

# CATALOGUE 2019



Downloaded  
from  
  
[www.cbradio.nl](http://www.cbradio.nl)

 **MIDLAND**<sup>®</sup>

ANNIVERSARY  
1959-2019

 YEARS



# DUALMIKE

THE SMART MICROPHONE THAT MODULATES FOR TWO

Dual Mike revolutionises the modulation rules, the first CB microphone to allow a dual connection: with the CB, via 4 PIN 48/68 connector (4 PIN, 6 PIN) and with the smartphone, via Bluetooth.

Combined with the CBTalk app, to talk whoever you want, where you want, without distance limits and with an excellent sound quality. Change channel, switch to Dual.

## THE FIRST DUAL PTT:

press at the top and transmit on the CB



## COMPATIBLE WITH EVERY CB

DUALMIKE is available in 3 versions so that it can be used with many CB models, even not Midland's.

\* Check the list of compatibility with competitors' CBs on the [midlandeurope.com](http://midlandeurope.com) website



4 PIN 48/68



4 PIN



6 PIN



DUALMIKE can be recharged via the USB socket on the microphone or from the CB socket connected to the USB socket of the cable.



## CUSTOMIZE THE LIGHT RING OF YOUR DUALMIKE (5 COLOURS)



# CB MICROPHONE

Dual mike is compatible with all Midland and the majority of CBs available on the market: choose between the 4 Pin 48, 4 Pin and 6 Pin version.

Choose your favourite color for the Light Ring and start talking with your travel friends.



ANALOG PTT



PREAMPLIFIED MICROPHONE



LIGHT RING FOR NOTIFICATIONS



LONG BATTERY LIFE



DUAL USB RECHARGE SOCKET





### THE FIRST DUAL PTT:

Press the PTT at the bottom to talk on the App.



### DUALMIKE

It combines the analog and digital world thanks to the Bluetooth connection, turning into a multi-purpose instrument: speakerphone, loudspeaker and the first CB (connected to CBTalk) that can communicate without any distance limit.



DUALMIKE has a 3W Super Bass loudspeaker to listen to excellent quality music.

### DSP FILTER TO ANSWER YOUR PHONE HANDS-FREE

DSP technology eliminates up to 80% environmental noise. Stop the noise from both windows and engine.

# BLUETOOTH MICROPHONE

The CB debuts online! Connect DUAL MIKE to your smartphone via Bluetooth, answer your phone in hands-free mode or listen to your favourite music, thanks to the 3W Bluetooth speaker integrated in the DUALMIKE.



DIGITAL PTT

3W

EXTRA LOUD SPEAKER

DSP

FOR AN EXCELLENT VOICE IN TX



HANDS-FREE PHONE



LISTEN TO MUSIC





CBTALK App allows you to add to the analogue channels another 80 digital channels up to 100 km away\*. Alternatively, select group mode, choose the one of your language and communicate with online users without distance limits. You can see them in real time on the map and report speed cameras, traffic or accidents, thanks to the geolocalized voice emergency signal.

\* Exclusive features for DUAL MIKE owners.

# CBTALK APP

The App that enhances your CB with all the functions listed above. You will finally be able to start modulating\* both analogically and digitally, with no more distance limits, blocking all unwanted users. All in total safety while driving, through the DUALMIKE.



ANDROID/IOS



NO DISTANCE LIMITS



MAP WITH USERS' POSITION



EMERGENCY ALERT



BLOCK UNWANTED USERS

\*For all TIM users, data traffic is free, all over Italy.



DOWNLOAD THE APP CBTALK

# INDEX

## CB AND RADIO

### VEHICLE AND PORTABLE CB

MIDLAND M-5	4
MIDLAND M-MINI	5
DUAL MIKE	6
MIDLAND M-10	7
MIDLAND M-20	8
MIDLAND M-30	9
MIDLAND M ZERO PLUS	10
ALAN 100 PLUS B	10
ALAN QUARANTOTTO	11
ALAN SESSANTOTTO	12
ALAN 48 PLUS MULTI B	13
ALAN 78 PLUS MULTI B	13
ALAN 42 DS	14

### WALKIE TALKIE

#### LEISURE

XT10	15
XT30	15
XT50 /XT50 ADVENTURE	16
XT60	17
XT70 / XT70 ADVENTURE	18
MIDLAND G5C	19
MIDLAND G7 PRO	20
MIDLAND G9 PRO	21
MIDLAND G10	22
MIDLAND G11V	23
MIDLAND G15	24
MIDLAND G18	25
MIDLAND GB1-R	26

#### TOURISM

MIDLAND ONDA	27
--------------	----

#### BUSINESS

MIDLAND BR01	28
MIDLAND BR02	29
MIDLAND BR03	30

### AMATEUR VHF/UHF

MIDLAND CT590 S	31
MIDLAND CT 890	32

MIDLAND CT 990	33
MIDLAND CT 2000	34
MIDLAND CT 3000	35

### PROFESSIONAL VHF/UHF

ALAN HP108/408L	36
ALAN HM135/70	37
ALAN HM106	37

### MARINE VHF

MIDLAND ARCTIC	38
----------------	----

## CB ACCESSORIES AND RADIO

### CB

MICROPHONES	40
MICROPHONE HOLDERS, BRACKETS, CABLES	41
LOUDSPEAKERS, REDUCERS, AMPLIFIERS	42
SWR METERS WATTMETERS, CHARGERS	43
CAR & TRUCK CB ANTENNAS	44
MAGNETIC CB ANTENNAS	46
MAGNETIC BASES, VHF/UHF ANTENNAS	47
BASIC, BALCONY, WIDE BAND ANTENNAS	48
BRACKETS, CONNECTIONS	49
CONNECTORS, CABLES	50
ANTENNA TECHNICAL FEATURES	51
SUMMARY TABLES	53

### RADIO

HEADSET MICROPHONES	55
HEADSETS FOR SOFTGUNNERS	57
SOFTAIR, PAINTBALL TACTICAL MASKS	58
HI-FI STEREO HEADPHONES	
WALKIE TALKIE CHARGERS	59
WALKIE TALKIE SUPPLY	60
VHF/UHF RADIO ACCESSORIES	61
PROFESSIONAL RADIO ACCESSORIES	61
ANTENNAS, CONNECTORS	62
BLUETOOTH	63
USB RECHARGER	63
WALKIE TALKIE SUMMARY TABLES	64
VHF/UHF SUMMARY TABLES	66

## CAMCORDERS

### DASH CAM

BIKE GUARDIAN	68
STREET GUARDIAN FLAT	69
STREET GUARDIAN GPS+	70
STREET GUARDIAN DUAL	71
TRUCK GUARDIAN WIRELESS	72
SUMMARY TABLE	73

### ACTION CAM

MIDLAND H9	74
MIDLAND H5+	75
MIDLAND H360 SMART	76
ACCESSORIES	77
SUMMARY TABLE	79

## STARTERS AND POWER BANK

ENERJUMP MINI	81
ENERJUMP	81
ENERJUMP WORK	82
ER300	83

## MOTORCYCLE INTERCOMS

2019 NEWS	85
MIDLAND INTERCOM RANGE	86

## MIDLAND GROUP

ABOUT US	88
----------	----

# *CB & RADIO*

**CB  
WALKIE TALKIE  
AMATEUR VHF/UHF  
PROFESSIONAL VHF/UHF  
MARINE VHF**



**MIDLAND®**

# MIDLAND M-5

## THE CB "IN THE MIKE"



BAND



EMERGENCY



DIGITAL SQUELCH



NOISE BLANKER



DUAL SPEAKER



USB PORT



2 PIN KENWOOD



EXTRA SMALL: 102x100x25mm

USB PORT

The CB world finds a new style with the **Midland M-5**, the "CB in the mike" to have everything on hand all the time, thanks to the buttons placed directly on the microphone with an LCD display to see channels, bands and settings.

The compact size and its particular configuration allow the radio to be placed in the storage compartment or even in the boot (with accessory cable extension).

**A new way to enjoy the CB that allows you to drive with a minimal cabin.**

### FEATURES

- Band: Multi (see page 54)
- 40 AM/FM channels
- Output power: 4W AM/FM
- Die-cast metal body
- "Handy" controls on the mike
- Selectable multicolour backlight (7 colours)
- Manual squelch 28 levels
- Digital squelch at 5 levels
- RF gain
- Scan
- Indication S-meter RX-TX
- Sliding mounting bracket

- Lighter power supply
- USB socket for charging electrical devices
- 2 pin Kenwood socket (microphone)

### PACKAGING AND CODES

1 radio, microphone with UP/DOWN keys, fixing screws, mounting bracket, power cord with cigarette lighter socket  
**code C1277**

**EXPORT VERSION:  
10W AM/FM - 400CH**

### R74574

2 mt. long microphone extension cord for M-5/M-30/CT3000



# MIDLAND M-MINI

## THE MULTIMEDIA KIT

USE YOUR WIRELESS CB WITH WA ACCESSORIES

**WA-CB C1276**  
Bluetooth adapter for M-Mini (optional)



EXTRA SMALL: 102x100x25mm



BAND



EMERGENCY



DIGITAL SQUELCH



NOISE BLANKER



BLUETOOTH READY



2 PIN



WIRELESS COMMUNICATION



### THE BLISTER VERSION

### CB GO, READY IN JUST A FEW MINUTES.

A complete pack, containing: M-Mini, the Midland multimedia mini-transceiver, power cord with cigarette lighter plug and Midland LC29 high-performance antenna, fitted with a magnetic base. Become a part of the CB community.

The first CB that opens the door to the Bluetooth connection (with WA CB adapter) giving the opportunity of combining the CB with a microphone or a wireless headset. Completely redesigned in both design and electronics **M-Mini** is so small that it can simply be placed inside the cabin, without complicated installations.

**For hands-free CB communication, in complete safety.**

### FEATURES

- 40 AM/FM channels
- Selectable frequency bands: I, I2, D4, EU, EC, PL, UK, IN (see page 54)
- Output power: 4W AM/FM
- UP/DOWN keys on the microphone
- Channels scan
- LCD display with S/meter
- Double squelch mode (9 and 28 levels)
- Adjustable reception attenuator (RF gain)
- Emergency channel 9/19
- External loudspeaker socket
- Midland 2-pin socket for external mic/spk (bluetooth accessories compatible)

### PACKAGING AND CODES

#### Box M-Mini:

1 radio, microphone with UP/DOWN keys, fixing screws, mounting bracket  
**code C1262**

#### Blister CB GO:

CB M-Mini, power cord with cigarette lighter socket, LC29 antenna, magnetic base.  
**code C1262.02**

**EXPORT VERSION:**  
**9W AM/FM - 400CH**

# DUAL MIKE

THE FIRST DIGITAL PRE-AMPLIFIED MIKE

NEW



ANALOGUE PTT  
DIGITAL PTT



BLUETOOTH 4.2



PRE-AMPLIFIED



SUPER BASS  
LOUDSPEAKER



HANDS-FREE PHONE



FOR A PERFECT  
VOICE IN TX



LISTEN TO MUSIC



LIGHT RING FOR  
NOTIFICATIONS



LONG LASTING  
BATTERY



DOUBLE USB  
RECHARGE SOCKET



4 PIN \*48/68\*



4 PIN



6 PIN



## THE CB MIKE BECOMES DUAL.

Replace your mike with DUAL MIKE and boost your CB.

DUAL MIKE contains in just one microphone:

- the **dual PTT** to use with the analogue CB and with the CBTalk App,
- a **hands-free facility** to answer calls without having to use your hands,
- a **superb speaker** to listen to music via Bluetooth.

See all the details inside the cover, page 1

## FEATURES

- Bluetooth 4.2
- Dual USB Micro Recharge socket
- 6 hours life with volume at 80%
- 15 hours life with CB use only
- 3W Audio Superbass
- Dual PTT
- Multifunction key
- Connecting cable to the traditional CB (available in 4Pin 48, 4Pin, 6Pin versions)
- Customisable Light Ring, with light indications
- Expansion of the CBTalk App functions

## PACKAGING AND CODES

Microphone, micro-USB recharge cable, microphone holder with adhesive support

**code C1283 DualMike 4 Pin 48**

**code C1283.01 DualMike 4 Pin**

**code C1283.02 DualMike 6 Pin**

## ACCESSORIES



**VM-DUAL**  
**code C1407**

Air vent fixed support



**AM-DUAL**  
**code C1408**

Dual Mike adhesive support kit



**KS-DUAL**  
**code C1413**

Dual Mike adhesive support and air vent fixed support



**ST DUAL**  
**code C1422**

Support with 12V power unit and 2 USB sockets



**AL-DUAL**  
**code C1403**

Voltage reducer 12V-5V Alan 48 and Micro USB

# MIDLAND M-10

## THE FIRST MULTIMEDIA CB

USE YOUR WIRELESS CB WITH WA ACCESSORIES

**WA-CB C1276**  
Bluetooth adapter (option)



BAND



EMERGENCY



DIGITAL SQUELCH



NOISE BLANKER



BLUETOOTH READY



USB PORT



2 PIN



4 PIN



USB PORT

WIRELESS COMMUNICATION

The first multimedia CB launched on the market in 2016, allows hands-free Bluetooth communication (with optional adapter). Full compatibility with traditional Midland accessories and a USB socket to charge any device. Find below the features of the **Midland M-10, the first multimedia CB produced by the people who have made CB history, Midland.**

### FEATURES

- Band: Multi (see page 54)
- LCD display, White Bright Light™
- White Bright Light™ backlight
- AM/FM switch
- Automatic digital squelch
- Selectable audio: internal, from earphones, both
- ANL: automatic noise limiter
- Noise Blanker System
- Emergency channel 9-19
- USB socket for smartphone and tablet recharging
- 2 pin socket for accessories

- External loudspeaker socket
- 4 pin microphone connector

### PACKAGING AND CODES

1 radio, microphone, fixing screws, mounting bracket, power cable with car power supply  
**code C1185**

**EXPORT VERSION:  
10W AM/FM - 400CH**

### THE FIRST CB RADIO ALLOWING WIRELESS COMMUNICATION THANKS TO MIDLAND BLUETOOTH DONGLES

See Radio Accessories Section, page 63

#### WA-MIKE C1263

The first Bluetooth microphone



#### WA31 C1202

Bluetooth microphone with air tube earpiece and PTT



#### WA21 C1201

Bluetooth headset microphone with PTT



#### WA29 C1203

Bluetooth headset microphone with neckband and PTT



# MIDLAND M-20

## THE ADVANCED MULTIMEDIA CB

USE YOUR WIRELESS CB  
WITH WA ACCESSORIES

WA-CB C1276  
Bluetooth adapter  
(option)



BAND



EMERGENCY



DIGITAL SQUELCH



NOISE BLANKER



BLUETOOTH READY



USB PORT



2 PIN



6 PIN



USB PORT

WIRELESS  
COMMUNICATION

Even more functions than its predecessor M10. Large LCD screen, knob to **change channel** (also on the mike), **display indicator** of the operating band are the three features that make the **M-20** model a really efficient multimedia CB. Like all Midland multimedia CBs, with this product communication is possible in wireless mode, thanks to the **Bluetooth WA accessories**, connected to the 2-pin socket.

### FEATURES

- Band: Multi (see page 54)
- Large LCD display, White Bright Light™
- White Bright Light™ backlight
- AM/FM switch
- Automatic digital squelch, digital S-Meter
- Selectable audio: internal, from earphones, both
- ANL and Noise Blanker System that can be selected and disabled
- 9-19 emergency channel and selectable priority channel
- Microphone with Up/Down and priority channel

- USB socket for smartphone and tablet recharging
- 2 pin socket for accessories
- External loudspeaker socket
- External S-Meter socket
- 6 pin microphone connector

### PACKAGING AND CODES

1 radio, microphone, fixing screws, mounting bracket, power cable  
**code C1186**

**EXPORT VERSION:**  
**10W AM/FM - 400CH**

# MIDLAND M-30

## THE TOP-OF-THE-RANGE M SERIES CB



BAND



EMERGENCY



DIGITAL SQUELCH



NOISE BLANKER



ROSMETER  
S-METER



AUDIO EQUALIZER



DUAL WATCH



8 MEMORY  
CHANNELS



TOT



12/24V



RJ45



If you are looking for a multi-function CB, this is the model for you.

Ready to give you the best of the M series, thanks to **6 programmable keys**, wide **multi-colour TFT display**, with **Dual Watch** function to monitor two channels at the same time. Automatic switch-on, display of the channel number or channel number plus frequency, make it **the perfect tool for communication professionals**.

### FEATURES

- Band: AM/FM Multi (see page 54)
- 6 programmable keys
- Wide colour TFT display
- Supply 12V-24V
- Metal alloy radio body for better heat

- dissipation
- Display of the channel number or channel number + frequency.
- Automatic adjustable Digital Squelch on 9 levels
- S-Meter/SWR Meter
- RF attenuator
- Scan function
- Dual Watch
- Customizable Roger Beep
- 9/19 emergency channels and priority channel
- Noise Blanker
- Audio equalizer
- Protection against polarity inversion
- 8 customizable memory channels
- TOT (Time Out Timer)

- Adjustable backlight
- Automatic switch-on
- Keypad lock
- Microphone with RJ45 connector with keys
- UP/DOWN/Priority channel

### PACKAGING AND CODES

1 radio, microphone, mounting bracket, fixing screws  
code **C1313**

**EXPORT VERSION:**  
**AMATEUR BAND 26-28MHZ 400CH 8W (AM)/15W (FM)**

### R74574

2 mt. long microphone extension cord for M-5/M-30/CT3000

### PROGRAMMING SOFTWARE PRG-30 C1318

Complete with USB connection for PC

# MIDLAND M ZERO PLUS

## THE 40-AM-FM-CHANNEL CB



BAND



CHANNELS



EMERGENCY



POWER 12V



4 PIN



Evolution of the excellent Midland M-ZERO, the new PLUS version adds the **FM band**. **ABS body** for practical and light use and with **SMD technology** for the electronic structure. With its **40 AM/FM channels**, this CB is extremely easy to use. **M-ZERO PLUS is definitely the best compromise between quality and price of the M line.**

### FEATURES

- Band: AM-FM (Poland-Italy)
- Channel display, black background with white texts
- UP/DOWN buttons
- Squelch
- Emergency memory channel: to immediately select the emergency channel (set by the user)
- RF Gain: sensitivity control in RX
- Quick Scan

- On/Off keypad beep
- 4-pin microphone connector

### PACKAGING AND CODES

1 radio, microphone, mounting bracket, fixing screws  
code **C1169.01**

EXPORT VERSION: 120CH

# ALAN 100 PLUS B

## THE ENTRY LEVEL CB



BAND



CHANNELS



EMERGENCY



POWER 12V



4 PIN



The CB that has accompanied car, caravan and truck drivers since 1998. An excellent product to enter the CB world with everything that is required to communicate. **An easy communication tool for everyone.**

### FEATURES

- Band: AM-FM
- Emergency channel 9-19
- Display channels
- Up/down buttons
- Squelch
- Transmission and reception led
- External speaker socket
- 4-pin microphone connector

### PACKAGING AND CODES

1 radio, microphone, mounting bracket, fixing screws  
code **C442.09**

# ALAN QUARANTOTTO

## THE KING OF CB

SINCE 1986  
THE BEST SELLER  
40CH CB

ONLY FOR  
ITALIAN MARKET

AM  
FM

BAND

40

CHANNELS



NOISE BLANKER  
SYSTEM



S-METER



POWER 12V



4 PIN "48"



The CB that made the communication history, returns completely renewed, but still faithful to the DNA of the historical product.

Thanks to its fame, very easy use and its **complete range of functions**, it has been the Italian best-seller for over 30 years.

A travelling companion and an **irreplaceable work tool for those who are driving every day.**

### FEATURES

- Band: AM-FM
- Noise blanker System
- MIC Gain: Mic gain control for a always perfect modulation
- RF Gain: set the gain of the antenna preamplifier
- FIL: set the intonation of the incoming signal
- ANL: automatic noise cut down
- Squelch
- PA: activating this switch the CB becomes a low frequency amplifier (with additional speaker)
- White LED backlight, for every light condition
- 4-pin microphone connector

### PACKAGING AND CODES

1 radio, microphone, mounting bracket, fixing screws

code **C217.09**

# ALAN SESSANTOTTO

## THE MYTHICAL 34-CHANNEL CB

SINCE 1983  
THE BEST SELLER  
34CH CB

ONLY FOR  
ITALIAN MARKET

AM  
FM

BAND

34

CHANNELS



NOISE BLANKER  
SYSTEM



S-METER



POWER 12V



4 PIN "48"



The brother of the mythical Alan Quarantotto, that made communication history, returns completely renewed, but still faithful to the DNA of the historical product. Since 1983 the **sales champion** in its category.

### FEATURES

- Band: AM-FM
- Noise blanker System
- MIC Gain: Mic gain control for a always perfect modulation
- RF Gain: set the gain of the antenna preamplifier
- FIL: set the intonation of the incoming signal
- ANL: automatic noise cut down
- Squelch
- PA: activating this switch the CB becomes a low frequency amplifier (with additional speaker)
- White LED backlight, for every light condition
- 4-pin microphone connector

### PACKAGING AND CODES

1 radio, microphone, mounting bracket, fixing screws  
**code C025.09**



# ALAN 48 PLUS MULTI B

## THE TOP-OF-THE-RANGE MULTIBAND



BAND



SIGNAL



EMERGENCY



MEMORY



DUAL WATCH



POWER 12V



6 PIN

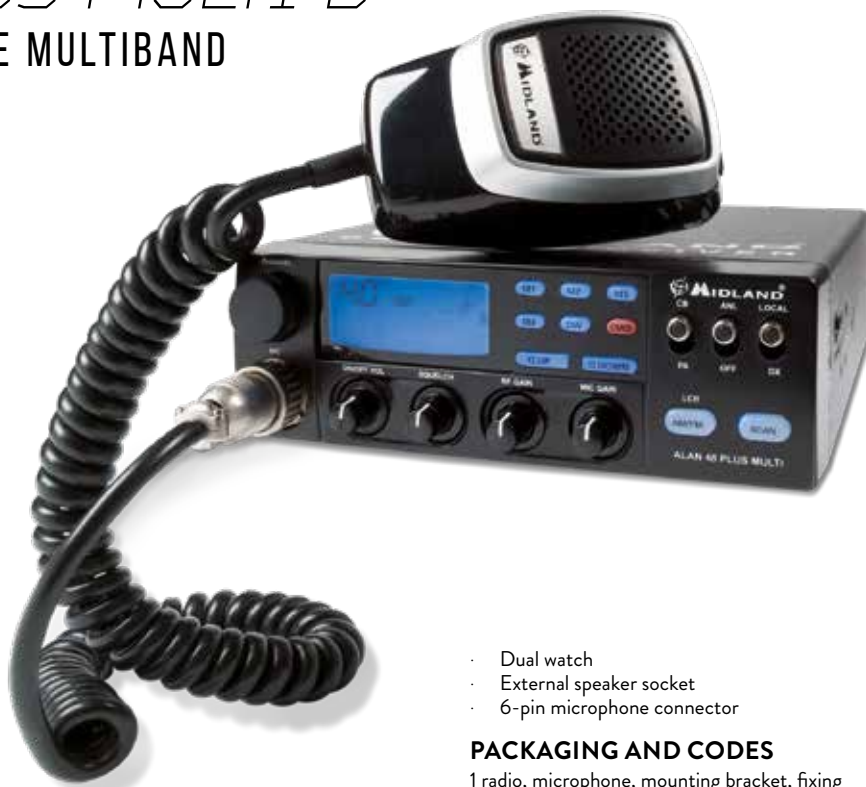

### The best-seller in Europe

Its classical design and advanced technology make the **Alan 48 plus Multi B** a cornerstone in the CB world.

### FEATURES

- Band: Multi (see page 54)
- Power: 1W/4W depending on the country
- Blue back-lit multifunction display
- "Precision series" microphone with Up/Down/Lock buttons
- Squelch
- RF Gain: sensitivity control in RX

- MIC Gain: microphone amplification
- 4 memory positions
- Emergency channel
- SCAN function

- Dual watch
- External speaker socket
- 6-pin microphone connector

### PACKAGING AND CODES

1 radio, microphone, mounting bracket, fixing screws  
code **C422.15**

EXPORT VERSION: 400CH

# ALAN 78 PLUS MULTI B

## THE COMPACT MULTIBAND



BAND



SIGNAL



EMERGENCY



POWER 12V



6 PIN



Its compact size and cutting-edge technology make it a **must in the CB world**.

### FEATURES

- Band: Multi (see page 54)
- Power: 1W/4W depending on the country
- Blue back-lit multifunction display
- "Precision series" microphone with Up/Down/Lock buttons

- Emergency channel
- Squelch
- External speaker socket
- SCAN function
- 6-pin microphone connector

### PACKAGING AND CODES

1 radio, microphone, mounting bracket, fixing screws  
code **C423.15**

EXPORT VERSION: 400CH

# ALAN 42 DS

## THE PORTABLE CB IS RENEWED WITH DS

N°1  
WORLD  
PORTABLE CB

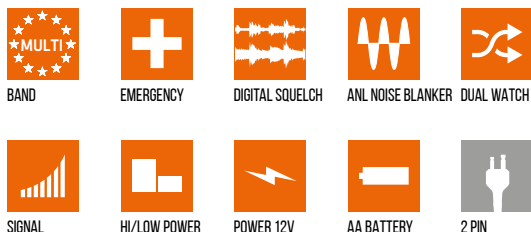

The portable CB transceiver "par excellence", **ALAN 42 DS**, with new electronic components to give a unique audio experience. It is fitted with **digital squelch, ANL filters and Noise Blanker** that removes all annoying noises caused by sources outside the vehicle. A multistandard transceiver that allows selecting **any European band and operate in all EU countries.**

### FEATURES

- Band: Multi (see page 54)
- Power: 1W/4W depending on the country
- Emergency channel (EMG)
- Keypad lock (LOCK)
- Battery status indicator
- High-lower power (H-L)
- Display back-lighting button
- AM-FM button selection
- SCAN function, Dualwatch
- Antenna socket: BNC
- Powered by 8 AA batteries or 12V
- 2-pin accessory socket

### PACKAGING AND CODES

1 radio, wall charger for 8 AA battery pack, empty battery pack for 6 AA Alkaline battery, empty battery pack for 8 AA rechargeable batteries with charging socket, adapter for car use with external SO 239 antenna socket, scratch resistant case, antenna, belt clip, wrist strap  
**code C1267**

**EXPORT VERSION: 400CH**

### OPTIONAL ACCESSORIES

Alan 42 DS is compatible with straight 2-pin accessories socket, see Radio Accessories Section page 55



**PB E42 - C602**  
Empty battery pack to charge 8 AA battery (not included)



**R74593 (Alan 42 DS/Multi)**  
**R17363 (only Alan 42 Multi)**  
Car adapter with socket for external antenna SO2399



**R17365**  
Wall adapter



**ANT 42 - C611**  
Antenna

**CB FLEX B- C394**  
Flex antenna 53 cm

# XT10

## 4 KM RANGE\*

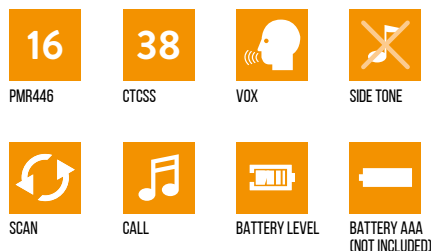

Light, very simple to use, coloured in order to avoid the usual "Hey, where did I put the walkie-talkie?", that's the **Midland XT10**. The entry level that combines technique, offering communications up to 4km, with simplicity and saving.

**Version:** PMR446  
**Colour:** Black/Red  
**Channels:** 8 + 8 preprogrammed  
**Tones:** 38 CTCSS

### FEATURES

- Communications up to 4 Km\*
- Side tone: end transmission tone muffler
- Keypad lock
- Auto power save: automatic battery saving
- Low battery indicator
- VOX, CALL, SCAN
- Power supply: 3 AAA batteries



### PACKAGING AND CODES

Blister with 2 radios, 2 belt clips  
**code C1176**



\* In optimal environmental and atmospheric conditions

# XT30

## 6 KM RANGE\*

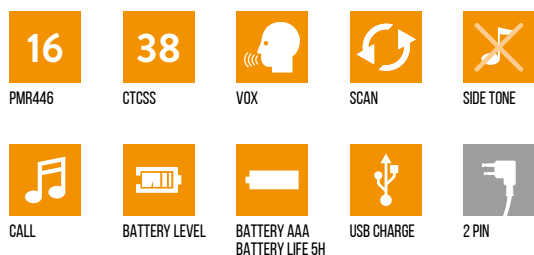

The **XT30** walkie-talkie concentrates in a light and easy to use tool everything you need to communicate up to 6 Km away. By means of a 5 hours battery life and a recharge via USB, this emerald-green jewel will make you run!

**Version:** PMR446  
**Colour:** Black/Green  
**Channels:** 8 + 8 preprogrammed  
**Tones:** 38 CTCSS

### FEATURES

- Communications up to 6 Km\*
- Rechargeable via USB
- Side tone: end transmission tone muffler
- Auto power save: automatic battery saving
- Low battery indicator
- Keypad lock, VOX, CALL, SCAN
- Power supply: 3 rechargeable AAA batteries (**up to 5 hours battery life**)
- 2-pin accessory jack/USB for charging



### PACKAGING AND CODES

Blister with 2 radios, 2 belt clips, 6 AAA rechargeable batteries, 2 way USB cable  
**code C1177**



\* In optimal environmental and atmospheric conditions

# XT50 / XT50 ADVENTURE

## 8 KM RANGE\*, WITH DESKTOP CHARGER



24 channels, 38 tones, communications up to 8 Km and 12 hours autonomy are just some of the features that make this **Midland XT50** walkie-talkie a real jewel of free radio-communications. Available also in the practical Adventure version with premium case!

**Version:** PMR446  
**Colour:** Blister Black/Gray  
 Valibox Black/Yellow  
**Channels:** 8 + 16 preprogrammed  
**Tones:** 38 CTCSS

### FEATURES

- Communications up to 8 Km\*
- Rechargeable via USB
- Side tone: end transmission tone muffler
- Keypad lock
- Auto power save: automatic battery saving
- Low battery indicator
- VOX with 3 levels of sensitivity
- CALL
- SCAN
- Power supply: Rechargeable battery pack (up to 12 hours battery life)
- 2-pin accessory jack/USB for charging

### PACKAGING AND CODES

**Blister:**  
 with 2 radios, 2 belt clips, 1 double desktop charger, 2 rechargeable battery packs, USB cable  
**code C1178**

**Valibox:**  
 with 2 radios, 2 belt clips, 1 double desktop charger, 2 rechargeable battery packs, USB cable, 1 wall adapter, 2 earphones MA21L  
**code C1178.01**

\* In optimal environmental and atmospheric conditions

# XT60

10 KM RANGE\*, WITH VOLUME KNOB  
AND QUICK DESKTOP CHARGER



69 LICENCE FREE LPD CHANNELS

When things get serious, when requirements increase, Midland responds and it does it with the **Midland XT60**, a dual band walkie-talkie that guarantees communications up to 10 km over 69 LPD and 24 PMR446 channels. Freedom and technology in just one tool.

**Version:** PMR446/LPD  
**Colour:** Black/Light blue  
**Channels:** 69 LPD + 24 PMR446  
(8 + 16 preprogrammed)  
**Tones:** 38 CTCSS + 83 DCS

## FEATURES

- Communications up to 10 Km\*
- Advanced radio with volume knob
- Rechargeable via USB
- Night vision display
- Side tone: end transmission tone muffler
- Keypad lock
- Auto power save: automatic battery saving
- Low battery indicator
- VOX with 9 levels of sensitivity
- CALL with 5 selectable tones
- SCAN
- High/low power selection
- Fast charger (3 hours)
- Power supply: Rechargeable battery pack (up to 12 hours battery life)
- 2-pin accessory jack/USB for charging

## PACKAGING AND CODES

Blister with 2 radios, 2 belt clips, 1 double desktop charger, 2 rechargeable battery packs, USB cable  
**code C1179**



\* In optimal environmental and atmospheric conditions

# XT 70 / XT 70 ADVENTURE

## 12 KM RANGE\*, WITH EARPHONES, VOLUME KNOB AND QUICK DESKTOP CHARGER

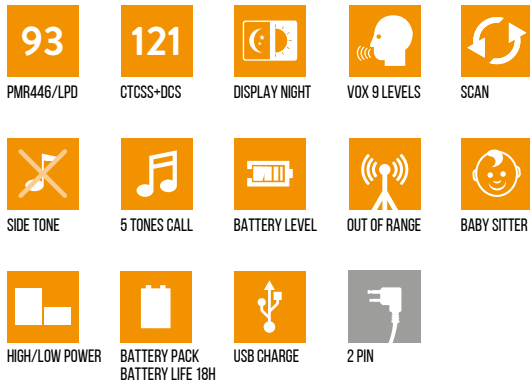

69 LICENCE FREE LPD CHANNELS



69 LPD and 24 PMR446 channels, 38 tones, communications up to 12 km and 18 hours autonomy. That's what the dual band **Midland XT70** walkie-talkie is, a perfect choice to communicate freely and safely. If you are also looking for an exceptional packaging, there's the Adventure version with premium case!

**Version:** PMR446/LPD  
**Colour:** Blister Black/Dark gray  
 Valibox Black/Yellow  
**Channels:** 69 LPD + 24 PMR446  
 (8 + 16 preprogrammed)  
**Tones:** 38 CTCSS + 83 DCS

### FEATURES

- Communications up to 12 km\*
- Premium Radio with Volume Knob
- Rechargeable via USB
- Side tone: end transmission tone muffler
- Wide display
- Out of range
- Baby-Sitting function
- Keypad lock
- Auto power save: automatic battery saving
- Low battery indicator
- VOX with 9 levels of sensitivity
- CALL with 5 selectable tones
- SCAN
- High/low power selection
- Fast charger (4 hours)
- Power supply: Rechargeable battery pack (up to 18 hours battery life)
- 2-pin accessory jack/USB for charging

### PACKAGING AND CODES

**Blister:**  
 with 2 radios, 2 professional belt clips, 1 double desktop charger, 2 rechargeable battery packs, USB cable, 2 earpiece microphones MA21-L  
**code C1180**

**Valibox:**  
 with 2 radios, 2 professional belt clips, 1 single desktop fast charger, 2 rechargeable battery packs, 2 wall adapters, 2 USB cables, earpiece microphones MA21-L  
**code C1180.01**

\* In optimal environmental and atmospheric conditions

# MIDLAND G5C

## WALKIE-TALKIE FOR THE FAMILY

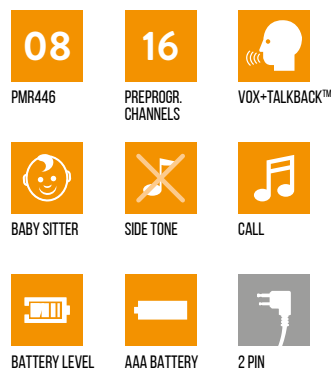

Valibox version  
**G5C WORK&HOBBY - C1192.03**



Family, passion, work. Three essential elements that make a meaningful life. To help you manage them better, we have created the **Midland G5C** walkie-talkie that combines modern and practical design with an extraordinary performance thanks to two practical versions: **Work&Hobby**, designed for work and leisure, and **Baby Monitoring**, enhanced with the BabySitter function.

**Version:** PMR446  
**Colour:** Black  
**Channels:** 8 + 16 preprogrammed  
**Tones:** 38 CTCSS

### FEATURES

- Baby Sitting function with dedicated channels
- Out of range
- Side tone
- Keypad lock
- Auto power save: automatic battery saving
- Low battery indicator
- VOX + Vox Talk Back
- Monitor
- CALL with 3 selectable tones
- Roger beep: end call tone
- Power supply: 3 AAA batteries
- 2-pin accessory jack
- Compatible wall charger: MW904

### PACKAGING AND CODES

**Blister:**  
with 2 radios, 2 wall chargers, 6 rechargeable Ni-MH AAA 800 mAh batteries, 2 belt clips  
**code C1192**

**Valibox:**  
with 2 radios, 2 wall chargers, 6 rechargeable AAA batteries, 2 microphones with adjustable earphones and PTT, 2 travel power supplies 12V  
**code C1192.03**

# MIDLAND G7 PRO

## THE BEST-SELLER IN THE WHOLE WORLD

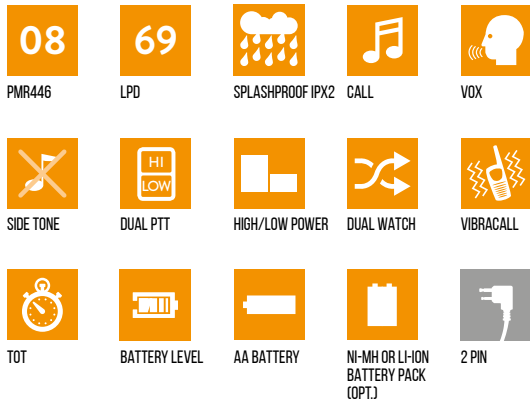

69 LICENCE FREE LPD CHANNELS

**Midland G7 PRO** is the radio for those who love outdoor activities. Hiking, airsoft, climbing, hunting are just a few examples of the perfect use of this walkie-talkie. A compact and elegant design that always accompanies you in your passions. Among the optional accessories you can choose the lithium battery pack to make it even lighter and more durable.

**Versions:** Dual band PMR446/LPD PMR446  
**Color:** Gray/Black - Mimetic Mossy Oak  
**Channels:** PMR446 8 - LPD 69  
**Tones:** 38 CTCSS + 104 DCS

### FEATURES

- Dual watch: to monitor 2 different channels at the same time
- Double PTT hi/low power
- Vibracall
- Keypad lock
- Auto power save: automatic battery saving
- Low battery indicator
- 3 types of VOX (Vox standard - Vox Baby-Sitting - Vox Bike) adjustable to 2 levels, for hands-free communication
- CALL with 5 different melodies
- SCAN
- TOT (Time Out Timer)
- Roger beep end call switchable
- Power supply: battery pack Ni-Mh 800 mAh or Li-Ion 1200 mAh (optional), 4 AA batteries
- 2-pin accessory socket
- Compatible wall charger: MW 904

### PACKAGING AND CODES

**Box single pack:**  
 1 radio, wall charger, 4 rechargeable Ni-MH AA 1.2V/1800 mAh batteries, belt clip  
**code C1090.14 Dual band black version**  
**code C1090.15 Dual band mimetic version**

**Box twin pack:**  
 2 radios, double desktop charger, wall adapter, 2800 mAh battery packs, belt clip  
**code C1090.06 Dual band black version**  
**code C1090.01 PMR446 only, version "E"**

### EXPORT VERSION 3W

WALKIE TALKIE - LEASURE TIME



# MIDLAND G9 PRO

## HIGH-PERFORMANCE

NEW



69 LICENCE FREE LPD CHANNELS

**Midland G9** evolves and becomes **PRO**. The excellent radio used in any outdoor context. With a 30% larger display, audio improved by 30%, a more powerful antenna and a dual PTT that allows you to instantly select high and low power, your communication becomes easier and more fun. **G9 PRO** is the first to introduce the 8 new frequencies of the PMR 446 band, which are freely used all over Europe, for communications free of overlaps and congestion by other users. Among the optional accessories you can choose the lithium battery pack to make it even lighter and more durable.

**Versions:** Dual band PMR446/LPD  
**Colour:** Black/Mimetic Mossy Oak®  
**Channels:** PMR446 16 +16 mem LPD 69

### FEATURES

- 8 new PMR446 channels
- 101 channels: 32 PMR446 (16+16 pre-programmed) + 69 LPD
- Extended frequency band: from 446.00625 to 446.19375MHz
- 38 CTCSS tones and 104 DCS codes
- High-performance loudspeaker
- Wide LCD display (30% wider than the previous version)
- Weatherproof IPX4
- Double PTT button for high/low power
- Emergency function
- Out of range function
- VOX with TalkBack™
- Side tone: end of transmission tone silencer
- Vibracall, Dual Watch
- Keypad lock, Scan, Monitor
- TOT (Time Out Timer)
- Low battery indicator and power save

- 12cm antenna to make the most of the full radio transmission power
- High-low power selection
- CALL button with 5 available tones
- Roger Beep: end of call tone (can be deactivated)
- Power supply: batteries or battery pack Ni-MH/Li-Ion (optional)
- 2-pin accessory socket
- Compatible wall charger: MW904

### PACKAGING AND CODES

1 radio, desktop charger with wall adapter, 4 rechargeable AA batteries (1800 mAh), belt clip  
**code C1385 Dual band black version**  
**code C1385.01 Dual band mimetic version**

### EXPORT VERSION 5W

WALKIE TALKIE - LEASURE TIME

# MIDLAND G10

## SIMPLE AND STRONG

08

PMR446

08

PREPROGR.  
CHANNELS



SCAN



VOICE  
ANNOUNCEMENT



BATTERY PACK



PROGRAMMABLE



2 PIN KENWOOD



### MULTI CA PB-G10 - C1218

6 position multicharger (optional)



Clean and compact design, technical performance, perfect also for professional communications in low-complexity environments, this is the **Midland G10** walkie-talkie. An entry level with great performance. Thanks to an immediate signalling of the selected channel and the programming software, the **G10** will be the perfect partner for all your needs.

**Version:** PMR446  
**Colour:** Black  
**Channels:** 8 + 8 pre-set sub-channels  
**Tones:** 51 CTCSS + 83 DCS normal/inverted

### FEATURES

- Output power: 500mW
- Channel spacing: 12.5KHz
- Channel scanning
- Function button beep
- Monitor
- Auto power save
- Power supply: 1200 mAh Li-Ion battery pack
- 2-pin Kenwood accessory socket

### PACKAGING AND CODES

1 radio, desktop charger, wall adapter, Li-Ion rechargeable battery pack (1200 mAh), belt clip  
**code C1107**

**EXPORT VERSION: 5W**

### PROGRAMMING SOFTWARE PRG 10 - C974.01

Customisation of channels and frequencies.

# MIDLAND G11V

## INCOMPARABLE AUDIO

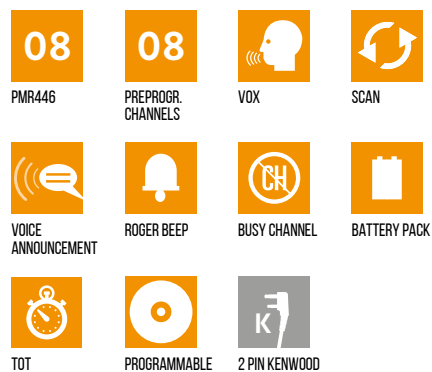

A huge attention to the smallest details is the key to guarantee high performance and maximum robustness to the **Midland G11V** walkie-talkie, that is equipped also with a metal chassis that enhances its strength, the "voice announcement" function to signal the selected channel vocally and a clear and ringing audio, for high quality communications

**Version:** PMR446  
**Colour:** Black  
**Channels:** 8 + 8 pre-set sub-channels  
**Tones:** 50 CTCSS + 105 DCS normal/inverted

### FEATURES

- Aluminium chassis
- Output power: 500mW
- Channel spacing: 12.5KHz
- VOX function (hands-free transmission)
- Voice announcement
- Channel scanning
- Function button beeps
- Roger beep
- Monitor
- TOT (Time Out Timer)
- Busy channel lock
- Auto power save
- Power supply: 1600 mAh Li-Ion battery pack
- 2-pin Kenwood accessory socket

### PACKAGING AND CODES

1 radio, desktop charger, wall adapter, rechargeable Li-Ion battery pack (1600 mAh), belt clip  
**code C966.04**

**EXPORT VERSION: 5W**

### PROGRAMMING SOFTWARE PRG 10 - C974.01

Customisation of channels and frequencies.

# MIDLAND G15

## THE INDESTRUCTIBLE

08

PMR446

08

PREPROGR.  
CHANNELS



WATERPROOF  
IP67



SCAN



VOICE  
ANNOUNCEMENT



VOX



ROGER BEEP



BATTERY PACK



PROGRAMMABLE



2 PIN MOTOROLA



### MULTI CA PB-G15 - C1251

6 position multicharger (optional)



WATERPROOF

Extreme sports, airsoft, work environments with low complexity but a high risk of damage to walkie-talkies, here are the situations where the **Midland G15** gives its best.

In fact, its metal chassis not only guarantees high impact strength but also withstands dust and immersion in water (up to 1 meter depth for 30 minutes).

**Version:** PMR446  
**Colour:** Black  
**Channels:** 8 + 8 pre-set sub-channels  
**Tones:** 50 CTCSS + 105 DCS normal/inverted

### FEATURES

- Aluminium chassis
- IP67 certified
- Output power: ≤500mW ERP
- Channel spacing: 12.5KHz
- Channel scanning
- Voice announcement
- Roger Beep, Auto power save
- Monitor, Squelch, Vox
- Power supply: Li-Ion 1600 mAh battery pack
- 2-pin Motorola accessory socket

### PACKAGING AND CODES

1 radio, desktop charger, wall adapter, rechargeable Li-Ion battery pack (1600 mAh), belt clip  
**code C1127**

### EXPORT VERSION 5W

### PROGRAMMING SOFTWARE PRG-G15 - C1131

Customisation of channels and frequencies.

# MIDLAND G18

## TOP OF THE RANGE



**MULTI CA PB-G15 C1251**  
6 position multicharger (optional)



WATERPROOF

WALKIE TALKIE - LEASURE TIME

Sometimes in your radio communication you need an extra gear, and for this reason we have created the **G18** walkie-talkie which, in addition to the metal chassis, is IP67 certified to withstand dust and immersion in water (up to 1 meter depth for 30 minutes). Add to this an LCD display an FM radio to guarantee superior performance to our top of the range.

**Version:** PMR446  
**Colour:** Black  
**Channels:** 8+91 (G18)  
pre-set sub-channels  
**Tones:** 50 CTCSS + 105 DCS  
normal/inverted

### FEATURES

- Aluminium chassis
- IP67 certified
- Output power: ≤500mW ERP
- Channel spacing: 12.5KHz
- Channel scanning
- Voice announcement
- FM radio
- Roger Beep, Auto power save
- Monitor, Squelch, Vox
- Scrambler and Compander
- Power supply: Li-Ion 1600 mAh battery pack
- 2-pin Motorola accessory socket

### PACKAGING AND CODES

1 radio, desktop charger, wall adapter, rechargeable Li-Ion battery pack (1600 mAh), belt clip  
**code C1145**

### EXPORT VERSION 5W

### PROGRAMMING SOFTWARE PRG-G15 - C1131

Customisation of channels and frequencies.

# MIDLAND GB1-R

## THE PMR446 THAT LOOKS LIKE A CB

NEW

PLEASE CHECK YOUR  
COUNTRY USE RESTRICTIONS

08

PMR446

91

PREPROGR.  
CHANNELS



SIDE TONE



TOT\*



SCAN



FLIP DISPLAY



VERY SMALL: 100x85x22mm

**GB1-R** guarantees wide-ranging communications and radio contact with other users equipped with PMR446 equipment. Superb solution for those who **travel by car or caravan**, above all due to the fact that, operating on PMR446 frequencies, it is not affected by disturbances generated by the engine of your vehicle. **GB1-R**, thanks to its very small size, integrated magnetic antenna and the supplied 12V cigarette lighter plug, can be installed and removed quickly without having to be fixed in the special compartment of the dashboard. The metal chassis makes it very robust to ensure excellent performance over the years.

**Version:** PMR446  
**Colour:** Black  
**Channels:** PMR446 8 + 91 progr.  
**Tones:** 50 CTCSS + 104 DCS

### FEATURES

- Microprocessor-controlled frequency
- 'Flip' function: the transceiver can be fitted with the speaker aimed downwards or vice-versa, the display is inverted by pressing a button
- Adjustable squelch on 9 levels
- SCAN function
- LCD display
- Integrated magnetic antenna
- TOT (Time out timer)\*
- Side tone: noise blanker at end of transmission
- Monitor function
- Busy channel (BCLO-Busy Channel Lockout)\*
- Broad/narrow band selection 25KHz/12.5KHz (only export version)\*
- High/low power (only export version)\*

### PACKAGING AND CODES

1 radio, microphone, microphone holder, integrated wired magnetic antenna, mounting bracket, fixing screws, supply cable with 12V car charger  
**code C1198.02**

### EXPORT VERSION 5W

\* Software programmable only Extra UE countries

### PROGRAMMING SOFTWARE PRG-GB1 - C1227

Complete with USB cable to connect to a PC.

# MIDLAND ONDA

## FOR TOURIST GUIDES AND GROUP TOURS



**MULTIPLE CHARGER CASE C922**  
Suitcase 15 positions (optional)



POCKET SIZE: 86x16x42mm

Midland Onda manages up to 100 groups simultaneously. (Different regulatory requirements may apply depending on the country in which Onda is sold).

### FEATURES

- Channels: 100 - Frequency: 472-474MHz
- 8 volume level
- Reception only for users
- Continuous transmission guaranteed to guide only, thanks to the dedicated accessory (MA28-TR)
- Auto power save: automatic battery saving
- Low battery indicator, Backlit LCD display
- Battery life up to 8 hours with battery pack
- Weight: 58g (without batteries)
- Dimensions: 86x16x42mm
- Power supply: Li-Ion battery pack (650mA)
- Dimensions: 86x16x42mm
- 1-pin stereo accessory socket

### PACKAGING AND CODES

#### Carton 50 receivers code C1069.01

50 receivers, waist clips, battery packs Li-Ion 3.7V 650 mAh and neck collars

#### Single pack code C1069

1 receiver, battery, waist clips and neck collar

#### Desktop charger 25pz code C921 (777 series)

Carton 25 double desktop chargers with relevant wall adaptors

#### Multiple charger case code C922

Rigid black suitcase to recharge 30 receivers with wall adaptor cable

### OPTIONAL ACCESSORIES

#### PB 777 C783

3,7V-650mAh Li-Ion battery pack

#### AL777 C803

Cigarette lighter power lead

#### R71968

Battery charger 220V for 2 desktop chargers/radios

#### R71969/R73579

2 positions desktop charger (no wall charger)

#### MW905 C887

Wall charger

#### A-777 TR C987

Earphone listening only, mono (1 pc)

#### A-777 TR C987.01

Earphone listening only, mono (100pcs)

#### S-777 TR C988.02

Protection sponge (500 pcs)

#### MA28-TR C559.05

Speak/listen microphone (PTT blocked in TX)

#### Rotating clip C1029

To rotate the radio when it is attached to the belt



### EARPHONE FOR ONDA C1209.01

Earphone listening only, mono, 2,5mm

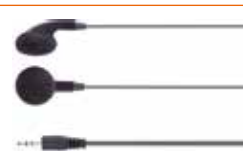

# MIDLAND BR01

## FOR SMALL BUSINESSES

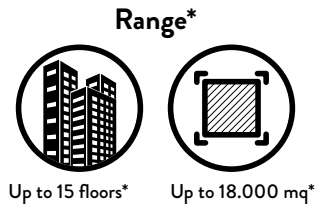

\* Depends on usage conditions



BUSINESS



RESTAURANTS



HOSPITALITY



WAREHOUSING

08

PMR446

08

PREPROGR.  
CHANNELS



VOICE  
ANNOUNCEMENT



BATTERY PACK  
BATTERY LIFE 37H



PROGRAMMABLE



2 PIN KENWOOD



Midland introduces the **BizTalk™** line, designed mainly for small businesses. Robustness, high mechanical and electronic reliability and an easy use make BR radios the perfect choice for those who need to communicate at work.

**Midland BR01** stands out for its extremely compact design and simple and clean lines that allow the radio to be used in a simple and immediate way.

**Version:** PMR446  
**Colour:** Black  
**Channels:** 8 + 8 pre-programmed  
**Tones:** 50 CTCSS + 232 DCS

### FEATURES

- Monitor function
- SCAN
- Squelch with 10 selectable levels
- Voice announcement
- **37 hours of battery life**
- Li-Ion 2800 mAh 3.7V battery
- Microphone/loudspeaker jack
- 2 pin Kenwood accessories socket

### PACKAGING AND CODES

1 radio, USB cable, rechargeable Li-Ion battery pack (2800 mAh), belt clip, wrist strap  
**code C1315**

### EXPORT VERSION 2W

DISCOVER THE HI PERFORMANCE ACCESSORIES PAGE 55-56

### PROGRAMMING SOFTWARE PRG-10 - C974.01

Customizing channels and subtones, activation/deactivation of specific functionalities.



# MIDLAND BR02

## FOR ALL TYPES OF BUSINESS

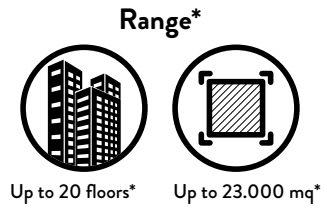

\* Depends on usage conditions



BUSINESS



RESTAURANTS



HOSPITALITY



WAREHOUSING

08

PMR446

08

PREPROGR.  
CHANNELS



SCAN



VOICE  
ANNOUNCEMENT



BATTERY PACK  
BATTERY LIFE 24H



PROGRAMMABLE



2 PIN KENWOOD



**MULTI CA PB-BR02 C1295**  
6 position multicharger (optional)



The Midland BR02 is designed for those who want something extra for their work. The aluminium chassis, guaranteed 5000 insertions headset jack and lithium battery with 21 hours autonomy, make it the ideal partner to communicate at work. It also has a 6-position multiple charger for simultaneous recharge, to have multiple radios always ready.

**Version:** PMR446  
**Colour:** Black  
**Channels:** 8 + 8 pre-programmed  
**Tones:** 38 CTCSS + 104 DCS

### FEATURES

- Aluminium chassis
- Monitor function
- SCAN
- Squelch with 10 selectable levels
- Voice announcement
- Microphone/loudspeaker jack
- Low battery indication
- Li-Ion 1800 mAh 3.7V battery pack
- Programmable from PC
- 2 pin Kenwood accessories socket

### PACKAGING AND CODES

1 radio with belt clip, desktop charger, wall adapter, Li-Ion 1800 mAh battery pack  
**code C1292**

DISCOVER THE HI PERFORMANCE ACCESSORIES PAGE 55-56



### PROGRAMMING SOFTWARE PRG-10 - C974.01

Customisation of channels and frequencies.

# MIDLAND BR03 FOR FASHION BUSINESSES

NEW

Range\*

Up to 22 floors\*    Up to 25.000 mq\*

\* Depends on usage conditions



**MULTI CA PB-BR03 C1353**  
6+6 position multicharger (optional)



**BR03** is the top-of-the-range in the **BizTalk™** line. The most "fashionable" Business Radio of the BR series, by means of its refined and elegant look & feel meets all the specific needs of the "Luxury" world. Fashion stores, hotels and high-end restaurants are the perfect environments where you can communicate while maintaining rigour and style. The peculiarity of the **Midland BR03** is the customizable LED dynamic matrix display.

**Version:** PMR446  
**Colour:** Black  
**Channels:** 8 + 91 pre-programmed  
**Tones:** 38 CTCSS + 104 DCS

### FEATURES

- Splashproof IPX2
- Output power: 500mW
- Voice announcement
- VOX adjustable to 10 levels
- SCAN
- Function key beep on/off
- Roger beep
- Auto Power Save
- Squelch adjustable to 10 levels
- LED dynamic matrix display with adjustable light intensity
- Battery level audio indicator
- **33 hours of battery life**
- Li-Ion 2300 mAh 3.7V battery pack

- Programmable from PC
- 2 pin Kenwood accessories socket

### PACKAGING AND CODES

1 radio with rotating belt clip, desktop charger, Li-Ion 2300 mAh 3.7V battery pack, wall adaptor with mini USB connector  
**code C1323**



### CUSTOMIZE THE DISPLAY

LED dynamic matrix with the name of your company or yours.

### PROGRAMMING SOFTWARE PRG-10 - C974.01

Customisation of channels and frequencies.

WALKIE TALKIE - BUSINESS

# MIDLAND CT590 S

## ENTRY LEVEL

NEW

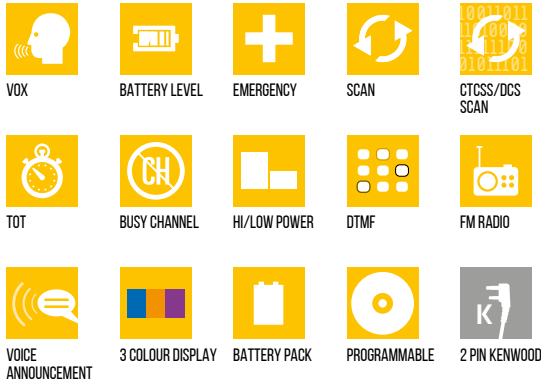

AMATEUR VHF/UHF

**Version:** VHF/UHF  
**Colour:** Black  
**Frequency:** 144-146MHz  
 (Exp. 136-174MHz)  
 430-440MHz  
 (Exp. 400-480MHz)  
**Output power:** 5W VHF/UHF

### FEATURES

- 50 tones CTCSS and 208 codes DCS
- 128 channels can be stored
- 1750Hz tone for repeater bridges
- Emergency SOS function
- Channel and dual band VHF/UHF displayed
- Operation mode: UHF/VHF, UHF/UHF, VHF/VHF
- Output power: 5W UHF/VHF
- 3-colour LCD display with selectable backlight

- FM radio receiver (87.5-108MHz)
- Scan, Dual Watch
- Channel Spacing: 25KHz/12.5KHz
- VOX adjustable on 10 levels
- Channel or frequency mode selection
- TOT (Time Out Timer)
- DTMF Function
- Reverse function
- Emergency alarm function
- Setting up and storing channel names
- CTCSS and DCS code search function
- PTT-ID
- BCL0 (Busy Channel Lockout function): busy channel lock function
- High/low power selection
- Frequency step: 2.5/5/6.25/10/12.5/25KHz
- Adjustable frequency offsets: 0-69.990MHz
- Adjustable Offset Direction

- Squelch adjustable on 9 levels
- Voice announcement of the selected function
- Keypad lock
- Power Save (battery economy)
- Programmable from PC
- Li-Ion 1500 mAh battery pack
- 2-pin Kenwood Accessory socket

### PACKAGING AND CODES

Radio, 1500 mAh 7.4V Li-Ion battery pack, desktop fast charger, wall adapter, antenna, belt clip  
**code C1354**

### PROGRAMMING SOFTWARE PRG10 - C974.01

Complete with USB connection cable for PC.

# MIDLAND CT 890

## INCOMPARABLE DISPLAY

VERSION WITH  
SCRAMBLER  
COMPANDER



**Version:** Dual Band VHF/UHF  
**Colour:** Black  
**Frequency:** 144-146MHz  
 (Export 136-174MHz)  
 430-440MHz  
 (Export 400-470MHz)  
**Output power:** 5W VHF/UHF

### FEATURES

- 105+105 (I-N) codes DCS/50 CTCSS tones
- 999 channels to store
- Channel spacing: 25KHz/12.5KHz
- SOS emergency function
- Operating mode: UHF-UHF, VHF-VHF and VHF-UHF
- Full duplex, repeater function
- Channel and dual band VHF/UHF displayed
- FM 88÷108 MHz radio receiver
- Scrambler, Compander
- Chronometer
- Built-in torch
- Frequency step: 5/6.25/10/12.5/25 kHz, 50/100 kHz
- Roger Beep tone at start/end of conversation
- Frequency scan with CTCSS/DCS
- DTMF
- Shift repeater
- Vox and Scan functions
- Back-lit display
- Optional displaying of channel number, channel number + frequency or frequency only
- TOT (Time Out Timer)
- Busy channel lockout (BCLO) function
- Squelch adjustable to 9 levels
- Keypad lock
- Hi/Low power selection
- Frequency setting and keypad channels
- Voice announcement of the selected function
- Inverted frequency function
- Frequency offset: 0-69.950 MHz
- Function/channel reset
- 2-pin Kenwood accessory socket

### PACKAGING AND CODES

Radio, 2600 mAh Li-Ion battery pack, desktop charger, wall adapter, antenna, belt clip, wrist strap  
**code C1170.01**

### PROGRAMMING SOFTWARE PRG10 - C974.01

Complete with USB connection cable for PC.

# MIDLAND CT990

## POWER NEVER SEEN BEFORE

NEW

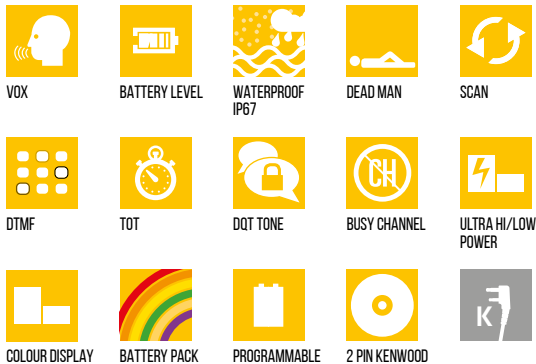

### 10W ULTRA POWER TRANSMISSION

### SUPPLIED WITH 2 ANTENNAS

- **Long antenna:** enhances the radio performance in TX/RX
- **Short antenna:** allows better handling

**CT990** is fitted with the Dead Man function, useful when you are on your own or isolated. This function constantly monitors the status of the person wearing the radio: if a change in position of the radio from vertical to horizontal (due to illness or injury) is recorded **CT990** emits an alarm that is sent to all users tuned to its frequency.

**Version:** Dual Band VHF/UHF  
**Colour:** Black  
**Frequency:** 144-146MHz  
 (Export 136-174MHz)  
 430-440MHz  
 (Export 400-470MHz)  
**Output power:** 10W VHF/UHF

### FEATURES

- 257 memory channels
- 83 + 83 DCS codes and 38 CTCSS tones
- Selectable channel spacing 25kHz/12.5 kHz
- Dual band VHF/UHF displayed
- Frequency band (settable according to

- country/area of use): 144-146 MHz & 430-440MHz (Rx/Tx).
- Operating mode: UHF/VHF, VHF/VHF or UHF/UHF
- Selectable channel step 25kHz/12.5 kHz
- IP67 certificate
- Dead Man function
- **DQT function (private conversation)**
- Wide colour LCD display
- Activation tones for repeater bridges
- Individual/group selective calls
- Side tone: end of transmission tone silencer
- VOX function
- Voice indication of the selected function "VOICE"
- Optional display of the channel number, channel number and frequency, channel name
- Inverted frequency function
- Scan function
- FM radio receiver
- Selectable transmission power: high (10W) or low (5W)

- Frequency offset
- Shift repeater
- "Busy channel lock" function
- Output power level indicator on the display
- Roger beep
- TOT (Time Out Timer)
- Keypad lock
- Reset of functions/channels
- Low battery voice announcement
- Li-Ion 2800mAh battery pack
- Accessory socket: 2 pin Kenwood

### PACKAGING AND CODES

Radio, **long and short antennas**, Li-Ion 2800mAh battery pack, belt clip, table charger, wrist strap, wall adapter.

**code C1339**

### PROGRAMMING SOFTWARE PRG10 - C974.01

Complete with USB connection cable for PC.



AMATEUR VHF/UHF

# MIDLAND CT2000

## THE FIRST VEHICULAR VHF/UHF



WATERPROOF  
IP54



POWER  
25/10/5W



CHANNELS  
203



TFT GRAPHIC  
DISPLAY



TOT



SCAN



REPEATER  
FUNCTION



EXTRA LOUD  
SPEAKER



PROGRAMMABLE



SUPERCOMPACT 115x125x43mm

**CT2000** is an amateur bi-band transceiver that works in VHF and UHF.

With a **25W output power** (adjustable), comparable to the power of professional transmitters, in spite of its very small size, a **powerful 3W loudspeaker** guaranteeing an excellent audio and a **wide multicolour graphic display** that allows seeing all set parameters clearly. **CT2000** stores up to **203 channels**, has **51 CTCSS tones and 208 DCS codes as well as the 1750/2100/1000/1450Hz tones to access repeater bridges**; it can also make selective calls. It is **IP54 certified** (protection against dust and splashes) to allow use even outdoors, such as on motorcycles or quads (ATVs). With a **compact multifunction microphone** with which the set functions can be quickly recalled.

**Programmable** using the optional software thanks to which you can customize the functions and buttons on the front of the radio.

**Version:** Dual Band VHF/UHF  
**Colour:** Black  
**Frequency:** 144-146MHz  
(Export 136-174MHz)  
430-440MHz  
(Export 400-470MHz)  
**Output power:** 25/10/5W

### FEATURES

- Resistant to splashes and dust, IP54 protection.
- Operating mode: UHF/VHF, VHF/VHF or UHF/UHF
- Selectable transmission power: high (25W) medium (10W) or low (5W)
- 104 + 104 DCS codes and 51 CTCSS tones
- 203 channels can be stored
- Dual band display (VHF / UHF), channel number or channel number and frequency, transmission power level
- Colour graphic display

- Activation tones for repeaters (1000/1450/1750/2100Hz)
- Bandwidth selectable on three levels 12.5 kHz/20 kHz/25 kHz
- Frequency inversion function
- Scan function
- Frequency offset and selectable offset direction
- TOT (Time Out Timer)
- Keypad lock
- Socket for external earphone

### PACKAGING AND CODES

Transceiver, microphone with keypad, fixing bracket, power cable, microphone holder  
**code C1321**

### PROGRAMMING SOFTWARE PRG-510 - C1104

Complete with USB connection cable for PC.

# MIDLAND CT3000

## THE PROFESSIONAL AMATEUR RADIO

NEW



WATERPROOF  
IP54



POWER  
25/10/5W



CHANNELS



TFT GRAPHIC  
DISPLAY



TOT



SCAN



REPEATER  
FUNCTION



EXTRA LOUD  
SPEAKER



"FLIP" DISPLAY



CUSTOMIZED  
BUTTONS



PROGRAMMABLE



Unlike the other models, **CT3000** can be defined "**professional**" as it has 6 customizable buttons on the front (P1-P6) through which you can set various functions, and not only: 2 functions can be associated to these 6 keys at the same time, divided into 2 groups of menus. To guarantee excellent communications even long range, CT3000 boasts high selectable **transmission power: 25W** (high), **10W** (medium) and **5W** (low).

Its metal chassis makes it an extremely robust radio, suitable for extreme situations, which also ensures better heat dissipation, very useful to prevent the radio from overheating. The IP54 certification ensures high protection against dust and splashes and also allows using the radio outdoors.

**CT3000** boasts the "**flip**" function: the radio can be rotated by 180° and the display will still be correct. The display is wide and multicolour.

**Version:** Dual Band VHF/UHF  
**Colour:** Black  
**Frequency:** 144-146MHz  
(Export 136-174MHz)  
430-440MHz  
(Export 400-470MHz)  
**Output power:** 25/10/5W

### FEATURES

- Operating mode: UHF/VHF, VHF/VHF or UHF/UHF
- Dual band display (VHF/UHF), channel number or channel number and frequency.
- Wide colour TFT display, rotating by 180°
- Scan of the stored channels
- Automatic adjustable Digital Squelch on multiple levels
- Scan function, Dual Watch, Roger Beep
- 200 customizable memory channels
- 104 + 104 DCS inverted codes and 51 CTCSS tones
- TOT (Time out Timer)
- Adjustable backlight

- Automatic switch ON/OFF
- Keypad lock
- Activation tones for repeaters (1000/1450/1750/2100 Hz)
- Bandwidth selectable on three levels 12.5 kHz/20 kHz/25 kHz
- Frequency inversion function
- Frequency step: 2,5 kHz-5 KHz 6,25 kHz-10 kHz-12,5kHz-20 kHz-25 kHz 30kHz-50 kHz.
- Frequency offset and selectable offset direction
- Output power level indicator on the display
- 12.6V+/- 10% power supply
- Microphone with RJ45 multifunction keypad

### PACKAGING AND CODES

Transceiver, microphone with keypad, fixing bracket, power cable, microphone holder, screws and protection fuse  
**code C1325**

### PROGRAMMING SOFTWARE PRG-3000 C1352

Complete with USB connection cable for PC.

### R74574

2 mt. long microphone extension cord for M-5/M-30/CT3000

# ALAN HP108/408L

QUALITY AND HIGH PROFESSIONAL PERFORMANCE AT A COMPETITIVE PRICE

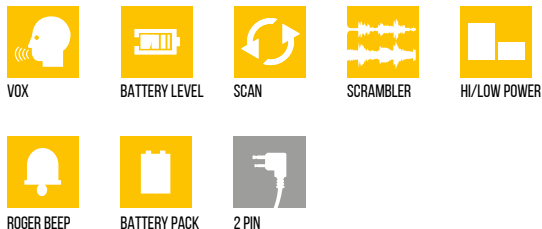

SIZE: 97x53x33mm

**HP108: VHF 136-174 MHz**  
**HP408L: UHF 400-470 MHz**

## FEATURES

- Protection IP54
- 256 CH (HP108); 298 CH (HP408L)
- Breakdown of channels according to groups
- Customisable switch on message
- Backlit LCD display
- Backlit keypad
- Standard CTCSS tones and digital DCS
- Selective calling 5 tones, 5+5 tones in the various standard formats
- Signal intensity indicator
- Built-in scrambler with 8 different selectable frequency codes
- Compander, Transponder function
- Adjustable power: max. 5W programmable at High/Low/Medium
- Battery life: up to 12 hours
- Built-in vox adjustable to 8 different sensitivity levels and 4 different delay levels
- 2-pin accessory socket

## PACKAGING AND CODES

Radio, quick desktop battery charger, Li-Ion 1600 mAh rechargeable battery, antenna, belt clip  
**HP108 code G1176.01** VHF 136-174MHz  
**HP408L code G1177.04** UHF 400-470MHz

## PROGRAMMING SOFTWARE PRG08 SERIE HP08 - G1184

Complete with USB connection cable for PC.



# ALAN HM135/70

## FOR ADVANCED COMMUNICATION SYSTEMS



EMERGENCY



SCAN



SCRAMBLER



HI/LOW POWER



**HM135: VHF 136-174MHz**  
**HM70: 66-88MHz**

### FEATURES

- 4 - 25W output power
- MIL STD 810 C D,E, F and IP54 (front panel only)
- More than 250 channels with usable settings
- CTCSS/DCS
- Programmable channelling

- Graphic LCD display
- 4 function buttons
- Phone book
- Standard and customised selective call
- Scrambler
- Kill/revive
- Remote use front panel
- 4W front speaker
- Standard and priority channel scan
- Talk around - Public Address function
- Flash memory
- programmable through PC

- Data transmission (compliant with ETS300-113)
- Standard DB25 accessories connector

### PACKAGING AND CODES

**HM135 code G934** VHF 136-174MHz  
Radio, power lead and support bracket

**HM70 code G1101** 66-88MHz  
Radio, power lead, support bracket and microphone

### PROGRAMMING SOFTWARE PRG35 FOR HM06, HM35 AND HM70 - G968

Complete with USB connection cable for PC.

# ALAN HM106

## REASONABLE PRICE PROFESSIONAL PERFORMANCE



EMERGENCY



SCAN



HI/LOW POWER



**HM106: VHF 136-174MHz**

### FEATURES

- Output power 4 - 25W
- MIL STD 810 C D,E, F and IP54 (front panel only)
- 99 channels

- CTCSS/DCS
- Programmable channelling
- 2-digit LED display
- 4 function buttons
- Selective Call
- 4W front speaker
- Standard and priority channel scan
- Talk around

- Public Address function
- Flash memory
- PC programmable

### PACKAGING AND CODES

Radio, standard microphone, power lead and support bracket  
**HM106 code G997** VHF 136-174MHz

### PROGRAMMING SOFTWARE PRG35 FOR HM06, HM35 AND HM70 - G968

Complete with USB connection cable for PC.

# MIDLAND ARCTIC

## THE MARINE RADIO

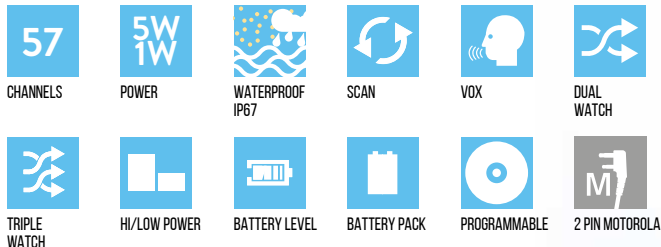

**MULTI CA PB-G15 - C1251**  
6 position multicharger (optional)



WATERPROOF

Midland Arctic is a VHF marine portable transceiver combining professional technical features with sturdiness and reliability. Its functions are all at hand, including the **button to access emergency channel 16 straight away**. The antenna can be removed and thanks to the standard **SMA connector**, it is possible to use other types of antenna. The management of the Charlie and Alpha channels and functions takes place via optional programming software.

### FEATURES

- IP67 waterproof certification
- Aluminium chassis
- Transmission power: 5W
- High/low power selection (5W/1W)
- 57 international channels
- Programmable channels (through software)
- Backlit wide LCD display
- Instant access to the emergency channel 16
- VOX, SCAN function
- Dual Watch/Triple Watch
- 10 different Squelch levels
- Priority channel
- Keypad lock
- Roger Beep (end of call tone)

- Keypad beep
- Flat battery indicator and automatic battery saver
- Power supply: Li-Ion battery pack
- 2-pin Motorola accessory socket

### PACKAGING AND CODES

Radio, desktop charger, wall adapter, Li-Ion 1600 mAh rechargeable battery pack, belt clip  
**code C1240**

**EXPORT VERSION:  
USA/CANADA CHANNELS**

### PROGRAMMING SOFTWARE PRG-G15 - C1131

Complete with USB connection cable for PC.

*C.B. & RADIO  
ACCESSORIES*



**MIDLAND®**

## CB ACCESSORIES

# MICROPHONES

### CB MICROPHONES 4-PIN "48" CONNECTOR



**NEW**

#### DUALMIKE

##### C1283

Bluetooth preamplified CB microphone.  
For Alan 48/68 and Midland 8001-XT



#### MIDLAND F48

##### C1022

Preamplified microphone with echo.  
For Alan 48/68 and Midland 8001-XT



#### MIKE MIDLAND

##### T059.01

Omni directional dynamic microphone.  
Impedance 500 Ohm.  
For Alan 48, Alan 68S, Midland 8001-XT

**FOR ITALIAN MARKET ONLY**



#### MDL4190

##### C074

Omni directional dynamic microphone.  
Impedance 500 Ohm.  
For Alan 48, Alan 68S, Midland 8001-XT

**FOR ITALIAN MARKET ONLY**



#### MDL-NC

##### C1155

Omni directional dynamic microphone.  
Noise-cancelling broadband microphone capsule.  
Impedance 460 Ohm.  
For Alan 48, Alan 68S, Midland 8001-XT

### CB MICROPHONES 6-PIN CONNECTOR



**NEW**

#### DUALMIKE

##### C1283.02

Bluetooth preamplified microphone for CB Multi Standard radios



#### MIDLAND F MULTI

##### C1023

Preamplified microphone with echo for CB Multi Standard radios



#### MR120

##### C404.01

Electret microphone with Up/Down buttons.  
For series Plus Multi, Excel, Midland 248, 248 XL, 278, Alan 121 and Midland 220 (no channel change)



#### MIKE MULTI

##### C714

"Precision series" microphone with Up/down buttons, Lock button.  
For series Plus Multi, Excel, Midland 248, 248 XL, 278, Alan 121 and Midland 220 (no channel change)



#### MIKE M20

##### C1266

Microphone with a stylish design with Up/Down/Priority buttons for M-20. Compatible also with Plus Multi B, Excel, Midland 248, 248XL, 278 and Alan 121 (for these models the Priority button becomes Lock).

## CB ACCESSORIES

# MICROPHONES, HOLDERS, BRACKETS, CABLES

### CB MICROPHONES 4-PIN CONNECTOR



**DUALMIKE  
C1283.01**  
Bluetooth preamplified CB microphone.  
For Midland M-10, M Zero/Plus, Alan 100 Plus B, Midland 200, Midland 203

NEW



**R51504**  
Original microphone Alan 100 Plus B/Midland 203. For Alan 100 Plus B, Midland 203, Alan 199, Midland 210 DSs



**MIDLAND F100  
C1021**  
Preamplified microphone with echo.  
For Alan 100 Plus B, Midland 200, Midland 203

### MICROPHONE HOLDERS



**PM3  
T431**  
Microphone-holder with screw fastening and bi-adhesive



**PMF  
T570**  
Microphone-holder with screw fastening and bi-adhesive, fluorescent

### BRACKETS



**SPM-48 DIN  
C791**  
DIN bracket for Alan 48 Plus Multi B/Excel Multi, Midland248/248XL



**SPM-78 DIN  
C792**  
DIN bracket for Alan 78 Plus Multi B, Midland 278, Midland M20



**SPM-100 DIN  
C807**  
DIN bracket for Alan 100 Plus, 100 Plus Euro, Alan 100 Plus B, 199-A, Midland 203, Midland 210, Midland M10



**SA 48  
T769**  
Complete with 1 bracket, 2 slides, 2 handles, 2 screws for Alan 48, 68S



**G1020.01**  
Dashboard kit white New Neptune

### CABLES



**R74574**  
2 mt. long mic extension cord for M-5/M-30/CT3000



**PRG-30  
C1318**  
Programming cable for M-30



**T060**  
3-pole lead with fuse-holder. Length: 160 cm. For Alan 48, Alan 68S

## CB AND RADIO ACCESSORIES

# SPEAKERS, VOLTAGE REDUCERS, AMPLIFIER

### SPEAKERS



**AU 20  
T775**  
External speaker 5W max



**AU 25E  
T681.01**  
External speaker 5W max.  
Recommended for VHF  
professional mobile transceivers  
Alan HM35/70/06



**AU 30  
T682**  
External speaker 12W max



**EH 800  
P348**  
External speaker 10W max

SUITABLE FOR OUTDOOR USE

SPECIFICATIONS	AU 20	AU 25E
Impedance	8 Ohm	8 Ohm
Rated power	2 W	3 W
Maximum power	5 W	5 W
Size in mm	65x55x65	100x60x60

SPECIFICATIONS	AU 30	EH 800
Impedance	8 Ohm	8 Ohm
Rated power	7 W	-
Maximum power	12 W	10 W
Size in mm	110x140x60	90x85x110

### VOLTAGE REDUCERS



**RDT 14/A  
C531**  
AUTOMOTIVE approval no.:  
e3 02 1050



**RDT 10/A  
C589**  
AUTOMOTIVE approval no.:  
e3 02 1049

SPECIFICATIONS	RDT 10/A	RDT 14/A
Switching technology	No	No
Input voltage	24-28 Vcc	24-28 Vcc
Output voltage	13,8 Vcc	13,8 Vcc
Size in mm	64x120x112	64x120x112

SPECIFICATIONS	RDT 10/A	RDT 14/A
Weight	670 g	580 g
Continuous	6 A	6 A
6'/3'	10 A/-	8 A/-
Max peak	10 A	10 A

### HF AMPLIFIER



**HF747  
C882**  
HF power amplifier AM-FM-SSB-CW  
(for amateur use only)



**BLW60  
T388.01**  
Replacement transistor for  
amplifiers (VHF and BS22)

SPECIFICATIONS	HF747
Frequency	HF
Power supply	12-14 Vcc
Current drain	8/10 A
Input power	0,5/10 W
Output power	100 W max
Mode	AM-FM-SSB-CW
Fuse	2 x 12 A
Size/Weight	109x210x35 mm/605 g

# SWR METER WATTMETERS, POWER SUPPLIES

## SWR METER WATTMETERS

### KW 505

#### C1165

KW 505 is a 2-function measurement instrument that operates on 1.5 - 150 MHz frequency range to constantly monitor any antenna.  
Power reading on two levels: 0-10W and 0-100W.



### KW 520

#### C530

Suitable for checking transmitter power and antenna adaptation, with two separate measuring lines, one from 1.8 to 200 MHz and the other from 140 to 525 MHz. This enables the simultaneous connection of 2 systems: one in HF/VHF and the other in VHF/UHF and select which to use to take the measurements with the specific switch. The measurement line selected is seen by the specific LED. With the possibility of measuring peak or medium value > Fine calibration of the index > Base scale duplicator button of power from 200 to 400 W.



#### SPECIFICATIONS

RF power	10W - 100W
R.O.S.	1:1 / ∞
Impedance	52 Ohm
Frequency range	1.5 - 150 MHz
Size	135x60x70 mm
Weight	280 g
Connector	SO239

#### SPECIFICATIONS

RF power	5W - 20W - 200W - 400W
R.O.S.	1:1 / ∞
Impedance	52 Ohm
Frequency range	1.8 - 200 MHz/140 - 525 MHz
Size	155x100x60 mm
Weight	730 g
Connector	SO239

## POWER SUPPLIES



SW35  
47500



SW57  
47510



SW79  
47520



SW102  
47530

The power supplies protected from short-circuit that can be used for radio applications and in electronics laboratories.

SPECIFICATIONS	SW35	SW57	SW79	SW102
Input voltage	220-230Vca-50Hz			
Output voltage	13,8Vcc			
Rated output current	Max 3-5A	Max 5-7A	Max 7-9A	10-12A

## CAR & TRUCK ANTENNAS

### SPACE ANTENNAS: ILLUMINATE WHEN TRANSMITTING

Midland Lux is the genesis of a new line of CB antennas, designed to make the installation of the best "CB radio" on vehicles. The antenna base is fitted with a waveguide that glows when it is crossed by radio frequency. It automatically illuminates when the radio is transmitting, thus signalling the correct operation of the device. It does not need any power and is totally waterproof. LUX1500-S and LUX 1000-S: Anti-theft and protection hinge. LUX 1500-PL e LUX 700-PL suitable for gutter, mirror, centre roof mount (accessories not included). With the KIT they become magnetic (see page 46).



**LUX 1000-S**  
C1258



**LUX 1500-S**  
C1259



**LUX 700-PL**  
C1330



**LUX 1500-PL**  
C1257



**X-TURBO 60**  
C871



**X-TURBO 80**  
C872



**ML143**  
C1164



**ML 145**  
T562.01



CAR & TRUCK ANTENNAS



ALAN PC 4  
T739



ALAN PC 6  
T736



ALAN PC 8  
T701



ALAN S9 PLUS  
T638



FUNK 90  
T638.04



FUNK 130  
T638.05



FUNK 150  
T638.06



MINI  
C593

MAGNETIC CB ANTENNAS



**KIT 226**  
LUX700-PL+120/PL



**KIT 224**  
LUX1500-PL+120/PL



**KIT 212**  
ML143+BASE M



**KIT 007**  
ML145 + 120/PL  
High power antenna with  
magnetic base Ø 120 mm



**MIDLAND 18-244M**  
T788  
Small antenna complete with  
lead and connector



**LC29**  
C1018



**LC65**  
C1020

## CB AND VHF/UHF RADIO ACCESSORIES

### MAGNETIC BASES, VHF/UHF ANTENNAS

#### MAGNETIC BASES



**BM-MP  
C1182**  
Developed for the MP120 antenna, it is designed to withstand high speeds. Equipped with scratch resistant magnet-covering cap. Supplied with universal DV 27 base (already installed).



**BM-MLC143  
C1183**  
Developed for the ML 143 antenna, it is designed to withstand high speed. Equipped with scratch resistant magnet-covering cap. Supplied with PL mount (already installed).



**BM 120/DV  
T057**  
BM 120 DV is designed to withstand high speeds. Equipped with scratch resistant magnet-covering cap. Supplied with universal DV 27 base (already installed).



**120/PL  
T036**  
Designed to withstand high speeds. Equipped with scratch resistant magnet-covering cap. Supplied with attachment for PL (already installed).



**BM 150/PL  
6782**  
Designed to withstand high speeds. Equipped with scratch resistant magnet-covering cap. Supplied with attachment for PL (already installed). Diameter: 15 cm.



**MINI MAGNETIC BASE  
6677**  
Mini BNC magnetic base (Ø35mm) with enormous adhesive force to accommodate shorter rubber antennas. with 2.40m-long RG 174 cable, BNC terminal connector.

**NEW**

**NEW**

#### VHF/UHF CAR & TRUCK ANTENNAS



**NW-2000  
C623  
F.O.W.\***



**NR-770R  
C626  
F.O.W.\***



**NR-770S  
C625**



**M-285  
C631**



**M-150 GSA  
C632**



**VH 1  
F092**

\* F.O.W.: Reclining structure. The reclining style guarantees that the antenna can move extensively in all directions, enabling the convenient parking of the car in the garage without removing the antenna. Equipped with a safety block for safe driving.

## BASIC, BALCONY, WIDE BAND ANTENNAS



CB BASE ANTENNAS,  
EQUIPPED WITH A  
SYSTEM TO PROTECT  
AGAINST WATER LEAK

**ENERGY NEW 1/2**

**T241.02**

Energy New 1/2 is telescopic base antenna, ground plane at 1/2 lambda, operating on 27MHz, built in anti-corrosion aluminium. All elements are telescopic and facilitate installation.



CB BASE ANTENNAS,  
EQUIPPED WITH A  
SYSTEM TO PROTECT  
AGAINST WATER LEAK

**ENERGY NEW 5/8**

**T242.02**

Energy New 5/8 is telescopic base antenna, ground plane at 5/8 lambda, operating on 27MHz, built in anti-corrosion aluminium. All elements are telescopic and facilitate installation.

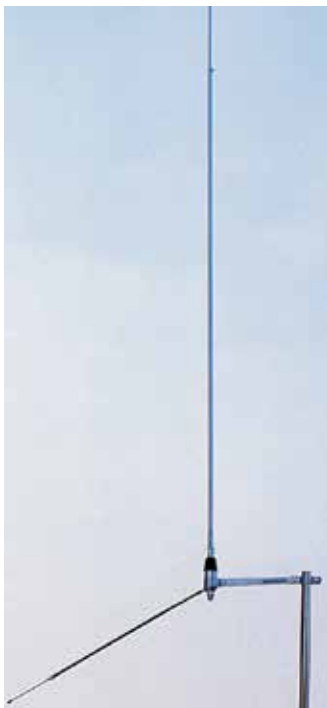

BASE STATION  
BALCONY ANTENNA

**BOOMERANG**

**6350**

Balcony/fix station 1/2 wave antenna for roof or balcony fitting. The aluminium radiants are 300cm in length. ROS calibration with adjustment of the whip on the shortest radian. Supplied with assembly kit. ROS: <1.2



BASE STATION  
BALCONY ANTENNA

**MINI BOOMERANG**

**6360**

Balcony/fix station 1/4 dipole antenna. Aluminium radiants 172cm, 173cm in radial length. Supplied with assembly kit.



BALCONY/STATION  
ANTENNA

**HURRICANE-STORM 27**

**63570**

1/2 wave fixed station/balcony antenna. It can be installed in attics, balconies etc. The ROS calibration is not required but the connecting cable must have the length specified in the user manual. Supplied with assembly kit.



WIDE BAND ANTENNA

**SKY BAND**

**6161**

Sky Band allows you to receive continuous coverage up to 1300 MHz and to broadcast on all amateur bands from 144 MHz upwards. It is therefore very useful for multiband devices and "dualbanders" for Full Duplex transmissions. Stainless steel whips.

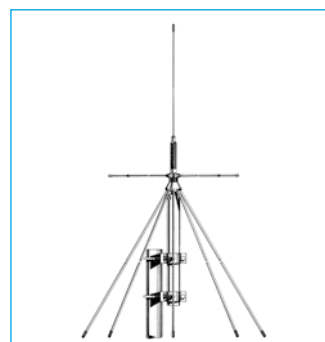

WIDE BAND ANTENNA

**ALL BAND**

**61700**

High performance antenna, usable both as receiving antenna and for transmission on various amateur radio frequencies. Made of stainless steel, chromed brass and anodised aluminium. Easy to install.

## ANTENNAS ACCESSORIES

### MOUNTS

#### ANTENNA MOUNTS



**AB-DAF XF106**  
C1430  
CB antenna holding BRACKET

**NEW**



**AB-SCANIA**  
**NEW GENERATION**  
C1430.01  
CB antenna holding bracket

**NEW**



**AB-RENAULT T**  
C1430.02  
CB antenna holding bracket

**NEW**



**AB-SCANIA R2/R3**  
C1430.03  
CB antenna holding bracket

**NEW**



**AB-VOLVO FH4**  
C1430.04  
CB antenna holding bracket

**NEW**



**AB-MERCEDES MP4**  
C1430.05  
CB antenna holding bracket

**NEW**



**AB-MAN TGX E5-E6**  
C1430.06  
CB antenna holding bracket

**NEW**



**AB-IVECO HIWAY**  
C1430.07  
CB antenna holding bracket

**NEW**



**GR-L**  
C1047  
Stainless steel mount.  
Size: 38x64x99mm



**GR-XL**  
C1048  
Stainless steel mount  
Size: 38x100x180mm



**GR PLUS**  
T786  
Gutter mount. Enables the Gutter  
mount installation of any mobile  
antenna without piercing the bodywork



**GR-F INOX**  
T751  
Gutter mount. In stainless steel for  
vehicle antennas, with fixing hole  
reducer



**GR-S INOX**  
T753  
Gutter mount. In stainless steel  
with double inclination for vehicle  
antennas, with fixing hole reducer



**DOWNPIPE 27**  
T054  
Gutter mount. Enables the Gutter  
mount installation of any mobile  
antenna without piercing the  
bodywork.  
The special rubber suction pad  
guarantees perfect adherence to the  
vehicle roof

## CB ACCESSORIES

### MOUNTS, CONNECTORS, CABLES



**SP-S INOX  
T752**  
Gutter mount. In stainless steel for vehicle antennas, with adjustable inclination and fixing hole reducer



**SP 21  
T390**  
Mirror mount. Enables the installation of any mobile antenna on the rear view mirror, avoiding unsightly holes in the bodywork



**DV 27 PL  
T599**  
Roof centre adapter  
DV/SO239

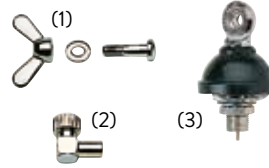

**SC 27**  
T441 Specific screw (1)  
LC 27/10-N  
T370.01 Connector (2)  
FC 27  
T478 Base for antennas (3)  
Screws, connector for FC 27 and base for Midland antennas

## CONNECTORS



**PL259/R  
T292.02**



**UG 255  
F076**  
Connector for BNC/SO239



**PL 259/RL  
T377**



**SA 95  
T211**  
SO239 connector RCA plug



**PL 259  
T205**  
Connector for RG8/RG213 cable

## CABLES



**RG58 T633 - R73895**  
3-piece lead for roof centre mount.  
Lead type: RG58 Length: 4m  
R73895 for PC antennas



**CENTRE ROOF MOUNT T301**  
Centre-roof mount for US antennas  
Lead type: RG58 Length: 3,5 m



**R 45/58-U T194**  
Connection lead for CB transceivers.  
Lead type: RG58 Length: 45 cm



**R 90/58-U T193**  
Connection lead for CB transceivers.  
Lead type: RG58 Length: 90 cm



**7581**  
1.5m coaxial cable extension with  
2 PL259 connectors



**75820**  
10m coaxial cable extension with  
2 PL259 connectors

**NEW**

**NEW**



**RG 213-U  
7462**  
100m roll



**RG 58-U  
7460**  
100m roll

## ANTENNAS SPECIFICATIONS

### CAR & TRUCK CB ANTENNAS

SPECIFICATIONS	LUX 1000-S/LUX 1500-S	X-TURBO 60/80	ALAN PC 4/6/8
Operating frequency	26-30MHz	26-28 MHz	25-30 MHz
Number of channels	120	200	150/240/130
Maximum applicable power	600/800	800 W (max 1500)/ 1000 W (max 1700)	400/600/800 W
R.O.S. min.in centre band	<1.2	<1.2	<1.2
Length (cm)	1200/1700	160/ 180	115/160/163
Impedance (Ohm)	50	50	50
Weight (g)	503/525	670/ 690	450
Whip material	Stainless steel	Steel	Stainless steel
Antenna connection type	3 pieces	3 pieces	3 pieces
Hole diameter (mm)	12.5	10	10
Lead (m)	4	4	4

SPECIFICATIONS	ALAN S9 PLUS	FUNK 90/130/150	MINI
Operating frequency	25-30 MHz	26-28 MHz	26÷28 MHz
Number of channels	200	-	40
Maximum applicable power	300 W	200/250/300 W	80 W
R.O.S. min. in centre band	<1.2	<1.2	1.2:1
Length (cm)	155	90/130/150	680
Impedance (Ohm)	50	50	50
Weight (g)	390	160/190/200	210
Whip material	Steel	Steel	Stainless steel
Antenna connection type	DV	DV	3 pieces
Hole diameter (mm)	12,5	10	12,5
Lead (m)	4	4/4/4	4 with PL259

You can find the LUX 700-PL, LUX 1500-PL, ML143 and ML145 technical specifications in the CB magnetic antennas table.

### MAGNETIC CB ANTENNAS

SPECIFICATIONS	KIT226 (LUX700-PL)	KIT224 (LUX1500-PL)	KIT212 (ML143)	KIT 007 (ML145)
Operating frequency	26-28 MHz	26-28 MHz	26-28 MHz	26-28 MHz
Number of channels	40	120	120	90
Maximum applicable power	600 W pep	1000 W pep	300 W pep	400 W pep
R.O.S. min. in centre band	<1.2	<1.2	<1.2	<1.2
Length (cm)	900	1645	170	146
Impedance (Ohm)	50	50	50	50
Weight (g)	330	358	1500	1600
Whip material	Stainless steel	Stainless steel	Stainless steel	Stainless steel
Mount	Magn. base 120mm with PL (SO239 antenna only)	Magn. base 120mm with PL (SO239 antenna only)	Magn. base 120mm with PL (SO239 antenna only)	Magn. base 120mm with PL (SO239 antenna only)
Hole diameter without magn. base (mm)	16	16	16	16
Lead (m)	4	4	4	2,9

SPECIFICATIONS	KIT 007 (ML145)	MIDLAND 18-244M	LC29	LC65
Operating frequency	26-28 MHz	26.965-27.405 MHz	26-28 MHz	26.965-27.405 MHz
Number of channels	90	40	40	40
Maximum applicable power	400 W pep	100 W	10/30 W (peak)	60/300 W (peak)
R.O.S. min. in centre band	<1.2	1:1,2	≤1.2:1	≤1.2:1
Length (cm)	146	66	29	115
Impedance (Ohm)	50	50	50	50
Weight (g)	1600	500	400	1000
Whip material	Stainless steel inox	Stainless steel inox	Stainless steel inox	Stainless steel inox
Mount	Magn. base 120mm with PL (SO239 antenna only)	Magn. base Ø 90 mm	Magn. base Ø 68 mm with PL	Magn. base Ø 120mm with PL
Hole diameter without magn. base (mm)	16	-	-	-
Lead (m)	2,9	2,75	4	4

### MAGNETIC BASES

SPECIFICATIONS	BM-MP	BM-MLC143	BM 120/DV	120/PL	BM-150PL	BM MINI
Frequency range	26-460 MHz	26-460 MHz	26-460 MHz	26-460 MHz	26-460 MHz	26-460 MHz
Max. speed	80/130 Km/h	80/130 Km/h	80/130 Km/h	80/130 Km/h	80/130 Km/h	80/130 Km/h
Base diameter	Ø 120 mm	Ø 120 mm	Ø 120 mm	Ø 120 mm	Ø 150 mm	Ø 35 mm
Weight	830 gr	940 gr	750 gr	700 gr	800 gr	100 gr
Lead	4m	4m	3m	3m	3.9m	2.4m

N.B.: Midland cannot advise on the gain of its antenna models, as this cannot be unambiguously defined. It varies according to various types of factors, such as installation position, length, system calibration, environmental conditions, etc.

## ANTENNAS SPECIFICATIONS

### VHF/UHF CAR & TRUCK ANTENNAS

SPECIFICATIONS	NW-2000	NR-770R	NR-770S	M-285	M150-GSA
Frequency	144/430 MHz	144/430 MHz	144/430 MHz	138-174 MHz	138-174 MHz
Type	1/2λ(144 MHz) 2x5/8λ(430 MHz)	1/23λ(144 MHz) 2x5/8λ(430 MHz)	1/4λ(144 MHz) 1/2λ(430 MHz)	5/8λ	1/4λ
Power	200 W	200 W	100 W	200 W	200 W
Length (cm)	98	98	43	100	51
Connector type	PL	PL	PL	PL	PL

### BASE CB ANTENNAS

SPECIFICATIONS	VH 1
Operating frequency	140:175 MHz
Maximum applicable power	100W
R.O.S. min. in centre band	1:1,2
Length (cm)	51
Impedance	50 Ohm
Weight	300 g
Whip material	Stainless steel
Connector type	PL259 (not supplied)
Hole diameter	12 mm
Lead	4m

SPECIFICATIONS	ENERGY NEW 1/2	ENERGY NEW 5/8
Operating frequency	25-29 MHz	144-430 MHz
Number of channels		
Maximum applicable power	500 W PEP	200 W
Impedance	50 Ohm	50 Ohm
Band R.O.S.	1.2:1	1.5:1
Length	5750/ 6500 mm	1700 mm
Weight	2,1/ 2,5 Kg	0.9 Kg
Ø support pole	30-40 mm	30-35 mm
Connector	SO 239	SO239
Whip	Aluminium	Fibreglass/steel

### BALCONY/STATION AND WIDE BAND ANTENNAS

SPECIFICATIONS	BOOMERANG	MINI BOOMERANG	HURRICANE STORM27	SKY BAND	ALL BAND
Operating frequency	27-30 MHz	27-30 MHz	25-29 MHz	RX only 70-1300MHz	25 - 1300 49,5...50,5, 120...180, 215...300, 415...465, 610...650, 700...1000, 1130...1300
Number of channels	200	150	100	-	-
Maximum applicable power	600W	450W	300W		300W (200W VHF/UHF)
Impedance	50 Ohm	50 Ohm	50 Ohm	50 Ohm	50 Ohm
Band R.O.S.	1:1:2	1:1:2	1:1.5		1:1.5
Length	275cm	172cm	96 cm	66 cm	160cm
Weight	880g	800g	700g		1140g
Ø support pole	-	-	-	1044g	25-54mm
Connector type	UHF Female	UHF Female	UHF Female	-	SD 1300 N = N-Female SD 1300 U = UHF-Female
Whip	Aluminium	Fibreglass	Aluminium	Aluminium	Aluminium, chromed brass, stainless steel, nylon

SKY BAND: since its bandwidth cannot assure a good SWR and this leads to a low TX performance, on the above table only the RX operating mode has been indicated (suitable for SCANNERS).

### VHF/UHF PORTABLES ANTENNAS (SEE PAGE 62)

SPECIFICATIONS	RH-707 FLEX	RH-701	RH-771	RH-775
Frequency	TX: 144/430 MHz	TX: 144/430 MHz	TX: 144/430 MHz	TX: 144/430 MHz
Type	1/4λ	1/4λ	1/4λ(144MHz) 1/2λ(430MHz)	1/4λ (144 MHz) 1/2λ (430 MHz)
Band	120-150/300-450 MHz 800-900 Mhz RX only	120-150/300-450 MHz 800-900 Mhz RX only	120-150/300-450 MHz 800-900 Mhz sRX only	120-150/300-450 MHz 800-900 MHz RX only
Length (cm)	21	21	40	14-41
Connector type	BNC	BNC	BNC	BNC

SPECIFICATIONS	RH-779	RH-519	RH-536	SRH-536	SRH-701
Frequency	TX: 144/430 MHz	TX: 144/430 MHz	TX: 144/430 MHz	TX: 144/430 MHz	TX: 144/430 MHz
Type	1/4λ - (144 MHz) 1/2λ - (430 MHz)	1/4λ - 2m/70cm	1/4λ - (144 MHz) 1/2λ - (430 MHz)	1/4λ - (144 MHz) 1/2λ - (430 MHz)	1/4λ
Band	120-150/300-450 MHz 800-900 Mhz RX only	120-150/300-450 MHz 800-900 MHz RX only	120-150/300-450 MHz 800-900 MHz RX only	300/800 MHz 900 MHz RX only	120-150/300-450 MHz 800-900 Mhz RX only
Length (cm)	14-41	20	36	37	21
Connector type	BNC	BNC	BNC	SMA	SMA

N.B.: Midland cannot advise on the gain of its antenna models, as this cannot be unambiguously defined. It varies according to various types of factors, such as installation position, length, system calibration, environmental conditions, etc.



## CB OVERVIEW TABLES

MODEL	MIDLAND M-5	MIDLAND M-MINI	MIDLAND M-10	MIDLAND M-20
Type	Vehicle multi-band CB	Vehicle multi-band CB	Vehicle multi-band CB	Vehicle multi-band CB
<b>General</b>				
Channels/Bands	see multi equipment table*	see multi equipment table*	see multi equipment table*	see multi equipment table*
Frequency range	26.565 - 27.99125 MHz	26.565 - 27.99125 MHz	26.565 - 27.99125 MHz	26.565 - 27.99125 MHz
Power supply voltage	12.6 V DC $\pm$ 10%	12.6 V DC $\pm$ 10%	12.6 V DC $\pm$ 10%	12,6 Vcc $\pm$ 10%
Size (WxHxD)/weight	110x120x25 mm/380 g	102x100x25 mm/450 g	122x35x195 mm/820 g	137x35x210 mm/930 g
Mic. connector	RJ45	-	4 pin	6 pin
<b>Receiver</b>				
Sensitivity for 20dB SINAD	<1 $\mu$ V	<1 $\mu$ V	<1 $\mu$ V	<1 $\mu$ V
Audio output power	3W+2W	4W max	4W max	4W max
Audio distortion	< 5%@1KHz	< 5%@1KHz	< 5%@1KHz	< 5%@1KHz
<b>Transmitter</b>				
Output power	1W/4W AM-FM	1W/4W AM-FM	1W/4W AM-FM	1W/4W AM-FM
Modulation	AM: 90% $\pm$ 5%, FM: 2KHz	AM: 90% $\pm$ 5%, FM: 2KHz	AM: 90% $\pm$ 5%, FM: 2KHz	AM: 90% $\pm$ 5%, FM: 2KHz
Max. current drain	<1600mA	<1600mA	<1600mA	<1600mA

MODEL	MIDLAND M-30	M ZERO PLUS	ALAN QUARANTOTTO	ALAN SESSANTOTTO
Type	Vehicle multi-band CB	Vehicle AM-FM CB	Vehicle AM-FM CB	Vehicle AM-FM CB
<b>General</b>				
Channels/Bands	see multi equipment table*	40 AM/40 AM -40 FM	40 AM -40 FM	34 AM-FM
Frequency range	26.565 - 27.99125 MHz	26.965 - 27.405 MHz	26.965 - 27.405 MHz	26.875 MHz - 27.265 MHz
Power supply voltage	12 $\pm$ 24V	12,6 Vcc $\pm$ 10%	12.6 V DC $\pm$ 10%	12,6 Vcc $\pm$ 10%
Size (WxHxD)/weight	120x37x160 mm/820 g	110 x 45 x 140 mm/665 g	165 x 55 x 205 mm/1,650Kg	165 x 55 x 205 mm/1,500Kg
Mic. connector	RJ	4 pin	4 pin "48"	4 pin "48"
<b>Receiver</b>				
Sensitivity for 20dB SINAD	<1 $\mu$ V	<1 $\mu$ V	<1 $\mu$ V	<1 $\mu$ V
Audio output power	4W max	2W max	4W max	4W max
Audio distortion	< 5%@1KHz	< 5% @ 1KHz	< 5%@1KHz	< 5%@1KHz
<b>Transmitter</b>				
Output power	4W AM-FM	4W AM-FM	4W AM-FM	4W AM-FM
Modulation	AM: 90% $\pm$ 5%, FM: 2KHz	AM: 90% - FM: 2KHz	AM: 90% $\pm$ 5%, FM: 2KHz	AM: 90% $\pm$ 5%, FM: 2KHz
Max. current drain	2000mA	1500mA	1500mA	1500mA

## CB OVERVIEW TABLES - TABLE OF CHANNELS/POWER/BAND FOR MULTI CB

MODEL	ALAN 100 PLUS B	ALAN 48 PLUS MULTI B	ALAN 78 PLUS MULTI B	ALAN 42 DS
Type	Vehicle AM-FM CB	Vehicle multi-band CB	Vehicle multiband CB	Portable multiband CB
<b>General</b>				
Channels/Bands	40 AM-40 FM	see multi equipment table*	see multi equipment table*	see multi equipment table*
Frequency range	26.965 - 27.405 MHz	26.565 - 27.99125 MHz	26.565 - 27.99125 MHz	26.565 MHz - 27.99125 MHz
Power supply voltage	12,6 V <sub>cc</sub> ± 10%	12,6 V <sub>cc</sub> ± 10%	12,6 V <sub>cc</sub> ± 10%	12,6 V <sub>cc</sub> ± 10%
Size (WxHxD)/weight	124x38x190 mm/1.2 Kg	180 x 50 x 150 mm/1 Kg	180 x 35 x 140 mm/0,850 Kg	70 x 140 x 30 mm/220 g (- batt)
Mic. connector	4 pin	6 pin	6 pin	2 pin Midland
<b>Receiver</b>				
Sensitivity for 20dB SINAD	< 1 µV	0,5±1 µV	< 1 µV	< 1 µV
Audio output power	4,5 W max	> 3W	> 2W	0.5W
Audio distortion	< 8% @ 1KHz	< 8% @ 1KHz	< 8% @ 1 KHz	3% @ 1KHz
<b>Transmitter</b>				
Output power	4W AM-FM	1W/4W AM-FM	1W/4W AM-FM	1W/4W AM-FM
Modulation	AM: 90%, FM: 2 KHz	AM: 90%, FM: 1.8 KHz +/- 0.2 KHz	AM: 90%, FM: 1.8 KHz +/- 0.2 KHz	AM: 90% ±5%, FM: 2KHz
Max. current drain	1100mA	1100mA	1100mA	900mA

## TABLE OF CHANNELS/POWER/BAND FOR MULTI CB

CODE	COUNTRY	MHZ
I	Italy 40 CH AM / FM 4 Watt	26.965-27.405
I2	Italy 34 CH AM / FM 4 Watt	26.875-27.265
D4	Germany 80 CH FM 4 Watt / 40 CH AM 4 Watt	26.565-27.405
EU	Europe 40 CH FM 4 Watt / 40 CH AM 1 Watt	26.965-27.405
EC	CEPT 40 CH FM 4 Watt	26.965-27.405
E	Spain 40 CH AM/FM 4 Watt	26.965-27.405
F	France 40 CH FM 4 Watt / 40 CH AM 4 Watt	26.965-27.405
PL	Poland 40 CH AM/FM 4 Watt	26.960-27.400
UK	England 40 CH FM 4 Watt + EC (40 CH FM 4Watt CEPT) or + 1 Italy 40CH AM/FM 4W (it depends on the radio model)	27.60125-27.99125 + 26.965-27.405
Sigla	Export Version	MHz
RU	Russia 400 CH AM/FM 4 Watt	25.615-30.105
PX	Poland 400 CH AM/FM 4 Watt Polish frequencies	25.610-30.100
SW	Sweden 24 CH FM 4 Watt 31 MHz	30.930-31.570
AU	Australia 40 CH AM 4 Watt	26.965-27.405
AM	Australia 10 CH AM 4 Watt	27.680-27.980
NZ	New Zealand 40 CH AM 4 Watt	26.330-26.770

**NB:** the multi CB radios can have different bands, as in the above table. For further information, please check the user manuals that can be downloaded on [www.midlandeurope.com](http://www.midlandeurope.com) in the **Support** section.

## RADIO ACCESSORIES

### MICROPHONES

#### MICROPHONES/EARPHONES WITH L-SHAPED 2-PIN ACCESSORY SOCKET



**MA 21-L**  
**C709.03**  
 Microphone with adjustable earpiece and selectable PTT/VOX, with curly cord



**MA 21-Li**  
**C709.07**  
 Microphone with earpiece (no VOX)

**NEW**



**MA 24-L**  
**C517.02**  
 Speak/listen microphone with selectable PTT/VOX



**MA 26 - L**  
**C515.01**  
 Speaker microphone with volume control and earpiece socket



**MA 28 - L**  
**C559.03**  
 Speak/listen microphone with selectable PTT/VOX  
 NB: MA28-G5 except Alan421-G5XT



**MA 30 - L**  
**C648.03**  
 Microphone with adjustable arm and selectable PTT/VOX



**MA 31 - L**  
**C732.03**  
 Microphone with pneumatic earpiece and selectable PTT/VOX



**MA 35 - L**  
**C652.02**  
 Headphone with microphone

#### MICROPHONES/EARPHONES WITH STRAIGHT 2-PIN ACCESSORY SOCKET



**AE30**  
**C851**  
 Microphone with arm and selectable PTT/VOX



**MA31**  
**C732**  
 Microphone with pneumatic earpiece and selectable PTT/VOX (OUT OF PRODUCTION)



**AE38**  
**C823**  
 Throat microphone with earphone, PTT and finger PTT

#### MICROPHONES/EARPHONES WITH 2-PIN KENWOOD ACCESSORY SOCKET



**BA21**  
**C1298**  
 Adjustable earpiece microphone and PTT. Ergonomic and comfortable, extremely robust cable for professional use. 2-pin "L" jack

**HIGH PERFORMANCE**



**BA24**  
**C1296**  
 Headset microphone. Ergonomic and comfortable, extremely robust cable for professional use. 2-pin "L" jack

**HIGH PERFORMANCE**



**BA22**  
**C1297**  
 Speaker microphone with PTT and rotating clip. Performant speaker with PTT and 360° rotating clip. 2-pin "L" jack

**HIGH PERFORMANCE**

## RADIO ACCESSORIES

### HIGH PERFORMANCE



**BA31**  
**C1299**  
Microphone with pneumatic headset and PTT. Comfortable to wear, discreet and flexible, high quality transparent hose. Extremely rugged cable for professional use. 2-pin "L" jack



**MA 21-LK**  
**C709.04**  
Microphone with adjustable earpiece and PTT, with curly cord. L-shaped 2-pin accessory socket

**MA 21-LKI**  
**C1306**  
Microphone with adjustable earpiece curly cord, competitive price.



**MA 21-XK**  
**C709.06**  
Microphone with adjustable earpiece and PTT. 2-pin "L" jack



**MA26 - LK**  
**C515.04**  
Speaker microphone with volume control and earpiece socket. L-shaped 2-pin accessory socket



**MA31-LK**  
**C732.04**  
Microphone with pneumatic earpiece. L-shaped 2-pin accessory socket

### MICROPHONES/EARPHONES WITH 1-PIN ACCESSORY SOCKET



**MA 21-SX**  
**C709.02**  
Microphone with adjustable earpiece and selectable PTT/VOX, with curly cord



**MA-NC1**  
**C983**  
Fabric neck collar with integrated headset and selectable PTT/VOX

### MICROPHONES/EARPHONES WITH 2-PIN MOTOROLA ACCESSORY SOCKET



**MA 25-M**  
**C1129**  
Waterproof speaker microphone, compatible with Midland G15/G18. 2-pin "L" jack



**MA 27-M**  
**C1130**  
Microphone with PTT, compatible with Midland G15/G18. 2-pin "L" jack



**MA 31-M**  
**C732.06**  
Microphone with pneumatic earpiece, compatible with Midland G15/G18. 2-pin "L" jack

### EARPHONES ONLY LISTENING TOURISTIC USE (1 USE)



**C1209**  
Earphone double ear pavilion, 3,5mm



**C1209.01**  
Earphone mono, 2,5mm



**C987.01**  
Earphone mono, 2,5mm

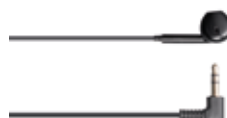

**C1243**  
Iphone style earphone, mono, 3,5mm



**C1282**  
Iphone style earphone, double ear pavilion, 3,5 mm



**C1324**  
Earphone, double ear pavilion, cable length 140 cm, 3,5 mm



## EARPIECE ACCESSORIES FOR SOFTGUNNERS

Action Line accessories stand out for their hard-wearing design, technical specifications, practicality and quality of materials. The Action Line is not compatible with Vox functions.

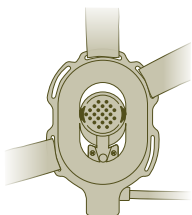

Speaker

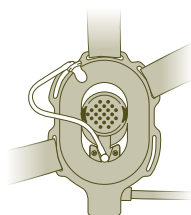

Air tube earpiece

**TO LISTEN WITHOUT BEING HEARD**

Military headset with detachable boom microphone (it can be worn on the right or on the left), tactical PTT and dual sound system (traditional speaker or air tube earpiece).

<p><b>BOW-M EVO</b> C1046.02 2-Pin Midland</p>	<p><b>BOW-M EVO K</b> C1046.03 2-Pin Kenwood</p>
--	--



**ABM TACTICAL**  
C855.01  
Earpiece microphone with adjustable arm and tactical PTT  
2-Pin Midland



**A21M**  
C858  
Earpiece microphone with standard PTT. 2-Pin Midland



**PTT+CLIP MIDLAND FOR BOW-M**  
C1088  
2-Pin Midland

**PTT+CLIP KENWOOD FOR BOW-M**  
C1088.01  
2-Pin Kenwood



**EP21**  
C859  
Earpiece 3,5mm jack socket (not compatible with Midland 777).

**LISTENING ONLY**

## ACTION LINE ACCESSORIES

RECOMMENDED  
BY US ASSOCIATIONS  
OF PAINT BALL AND  
SOFT AIR

# SAVE PHACE TACTICAL MASKS

### DOPE SERIES

Voodoo Magic C1058.05

Diablo C1058.06

Ghost Stalker C1058.07

#### SPECIFICATIONS:

Polycarbonate thermal pane clear lens with AF/AS/UV coating  
Material: tough, durable high impact plastic;  
interior: standard foam (not replaceable)  
Adjustable strap with sure grip technology  
Forehead protector and visor included  
Awesome custom SP exclusive graphic design



### OU812 SERIES

Flesh Phace C1058.09

Carnage C1058.10

Lazarus C1058.11

#### SPECIFICATIONS:

Material: specially formulated high impact plastic;  
interior: plush replaceable, washable and interchangeable foam.  
Adjustable strap with sure grip technology Visor and cloth stuff sack included



### SO PHAT SERIES

War Lord C1058.15

Boo C1058.17

Digi C1058.18

#### SPECIFICATIONS:

Polycarbonate lens with AF/AS/UV coating  
Material: specially formulated high impact plastic;  
interior: soft plush replaceable, washable and interchangeable foam  
Adjustable strap with sure grip technology  
Included: visor, forehead protector, cloth stuff sack,  
1 clear lens and 1 additional replacement  
Colored lens



### DISS SERIES

Intimidator C1058.02

Scar Phace C1058.04

#### SPECIFICATIONS:

Polycarbonate thermal pane clear lens with AF/AS/UV coating  
Material: high impact special formulated plastic;  
interior: "plush" foam (not replaceable)  
Adjustable strap with sure grip technology  
Forehead protector and visor included



### MARKS A LOT SERIES

Sharpie C1058.13

Assassin C1058.14

#### SPECIFICATIONS:

PC single pane clear lens with AF/AS/UV coating  
Material: high impact plastic; interior: sweat absorbent,  
replaceable, washable and interchangeable foam  
Comes in one color-bone; can be air brushed or painted  
Forehead protector and nice stuff bag included



### ACCESSORIES



Clear thermal lens  
C1059



Dark smoked thermal lens  
C1059.01



Yellow thermal lens  
C1059.02



Mirrored yellow lens  
C1059.04



RWI (Replaceable/  
Washable/Interchangeable)  
foam C1060

## WALKIE TALKIE ACCESSORIES

# HI-FI STEREO HEADPHONES, CHARGERS



Subzero is a Hi-Fi stereo headset with waterproof fabric on the outside and warm eco fur lining, integrated into a cosy adjustable ear warmer system to be worn on the back of the neck. Answer your phone calls and listen to music with great sound quality.

Also available in the summer version, SubzeroSun, with breathable fabric on the outside and fresh cotton on the inside. **Included in the package:** cable with microphone and Command/Answer function for mobile phones or Play/Pause for music (iPod, iPhone, MP3 and the best mobile phones), cable with microphone and PTT for connection to 2-Pin Midland transceivers.

### WINTER SUBZERO

Colours available for the winter:

Black	C936.03
Camouflage	C936.07
Yellow	C936.08
Black leather	C936.13
Black pierced fabric	C936.19

### SUBZERO SUN FOR THE SUMMER SEASON

Colours available in a pierced fabric:

Black	C936.17
Orange	C936.18

## DESKTOP CHARGERS



### R73713

Double desktop charger  
**Attention: to be used only with R73168 wall charger.**

G7 Pro

### R73579

Double desktop charger

Midland 777  
Onda

## MULTIPLE DESKTOP CHARGERS

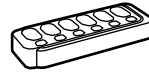

### MULTI CA PB-BR03

C1353  
6+6 position multicharger

BR03

**NEW**

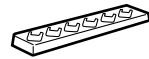

### MULTI CA PB-BR02

C1295  
6 position multicharger

BR02



### MULTI CA PB-G15

C1251  
6 position multicharger

Midland G15,  
G18, Arctic



### MULTI CA PB-G10

C1218  
6 position multicharger

Midland G10

## WALL CHARGERS



### MW904

C689  
Wall charger

G9/G9 Plus,  
G7XT/Pro,  
G6XT, G5XT,  
G8, M24-48-99

### MW905

C887  
Wall charger

Midland/  
Alan777, Onda,  
Midland G12,  
G5 R1, Pacific

### R71968

Wall charger with double jack

Midland/  
Alan777, Onda

## WALKIE TALKIE ACCESSORIES

### POWER, ADAPTERS

#### BATTERIES



**PB-PRO**  
**C1148**  
1200mAh Li-Ion rechargeable battery pack  
**Midland G7 Pro**

**PB-X6**  
**C1300**  
3,6V 700 mAh Ni-MH rechargeable battery pack  
**XT-50/60**

**NEW**

**PB-X7**  
**C1301**  
3,6V 1000 mAh Ni-MH rechargeable battery pack  
**XT-70**

**NEW**

**PB-BR01**  
**R74611**  
2800mAh Li-Ion rechargeable battery pack  
**BR-01**

**NEW**

**PB-BR02**  
**C1305**  
1800mAh Li-Ion rechargeable battery pack  
**BR-02**

**NEW**

**PB-BR03**  
**R01916**  
2300mAh Li-Ion rechargeable battery pack  
**BR-03**

**NEW**

**PB D-200**  
**C1265**  
1800mAh Li-Ion rechargeable battery pack  
**Midland D-200**

**PB G6/G8**  
**C881**  
800mAh Ni-MH rechargeable battery pack  
**Midland G8, G6, M24/48/99-S**

**PB-ATL/G7**  
**C784**  
800mAh Ni-MH rechargeable battery pack  
**Midland G7, G9, Pacific**

**PB-777**  
**C783**  
650mAh Li-Ion rechargeable battery pack  
**Midland/Alan 777 and Onda**



**PB-G10**  
**C1126**  
1200mAh Li-Ion rechargeable battery pack  
**Midland G10**

**R74421**  
1200mAh Li-Ion rechargeable battery pack  
**Midland G10 Mimetic**

**PB-G11**  
**C967**  
1600mAh Li-Ion rechargeable battery pack  
**Midland G11**

**PB-G15/18**  
**C1128**  
1600mAh Li-Ion rechargeable battery pack  
**Midland G15/ G18/Arctic**

**PB200/400**  
**C846**  
1200mA Li-Ion rechargeable battery pack  
**Midland G14**



**BATTERY ELIMINATOR**  
**C1406**  
Battery eliminator with power supply cable (cigarette lighter plug)  
**Midland G15 Midland G18 Arctic**

**NEW**

#### CIGARETTE LIGHTERS



**AL777**  
**C803**  
Cigarette lighter power lead  
**Midland/ Alan777, Midland G5 R1, G12, Pacific**

**ALG7**  
**C814**  
Cigarette lighter power lead  
**Midland G9, G8, G7, G6, G5XT**

#### ADAPTER



**C829**  
To ensure the compatibility of all equipment with 1-pin - 2,5mm stereo equipment with 2-pin accessories.  
**Midland G5/777**



## VHF/UHF - PROFESSIONAL RADIO ACCESSORIES

### VHF/UHF

#### MICROPHONES



**R73725** CT 510

Microphone with earpiece

See other earpieces/  
microphones with 2-pin  
Kenwood accessory  
socket, page 55

#### DESKTOP CHARGERS



**CA-CT 790** CT 790  
**R72767**

Quick desktop charger with wall  
adapter

**R73642** CT 510

Desktop battery charger (to be  
used with the USB cable, code  
R73644)

**R74116** CT890

Quick desktop charger with wall  
adapter

#### CABLES



**R73644** CT 510  
USB cable



**CLONING CABLE** CT 710  
**R73727** CT 890

It allows the transfer of data/  
settings from one radio to  
another (not included) CT590  
CT690

#### BATTERIES



**PB-AA890** CT 890  
**C1212**

Empty battery pack to charge  
5 AA battery (not included)

**PB200/400** CT 200/400  
**C846** CT 210/410/710

7,4Vcc - 1200mAh Li-Ion  
rechargeable battery

**R73645** CT 510

1300mAh Li-Ion rechargeable  
battery pack

**PB CT 890** CT 890  
**C1172**

2600mAh Li-Ion rechargeable  
battery pack

### PROFESSIONALS

#### MICROPHONES



**MK35-K** HM35, HM70  
**G1003.01**

Microphone with keypad

#### SPEAKER



**AU25E** HM35, HM70,  
**T681.01** HM06

External speaker max. 5W

#### REMOTE CONTROL



**G1016** HM35, HM70

Remote control kit including  
5 m extension lead with  
connectors, brackets, screws.

#### CHARGER



**RC45** HP450-2A  
**G1066**

Quick desktop charger

#### BATTERIES



**BP0518** HP06, HP70,  
**G811.03** HP446 extra

1800mAh Ni-MH  
rechargeable battery

**BP08** HP08  
**G1192**

1600mAh Li-Ion rechargeable  
battery

**BP 4522** HP450 2A  
**G1068**

2200mAh Li-Ion rechargeable  
battery

**WALKIE TALKIE, PROFESSIONALS, VHF/UHF RADIO ACCESSORIES**

*ANTENNAS, ADAPTERS*

**WALKIE TALKIE ANTENNAS**



**G7 FLEX**  
**C646.01**  
Flex antenna with adapter. Length: 35cm. For Midland **G7** line, **G8, G9, G14, G11, G15, G18**



**R72770**  
Short antenna. Length: 9 cm For Midland **G11, G14, G15, G18**



**R73197**  
Long antenna. Length: 16 cm For Midland **G11, G14, G15, G18**



**ANT710**  
**C1051**  
For CT510, CT710, CT890



**R74455**  
For CT690, CT590, CT790, CT200, CT400



**RH-707 FLEX**  
**C635**  
Flex-Tilt

**PROFESSIONAL ANTENNAS**



**HA105-LB1**  
**G885.01**  
Antenna 136-146MHz For **HP105**



**HAUN-VM**  
**G952**  
Antenna 150-161MHz For **HP 06/35**



**HAUN-VH**  
**G953**  
Antenna 161-174 MHz For **HP06/35**



**RH-701**  
**C634**  
Flex



**RH-771**  
**C637**  
Flex



**RH-775**  
**C638**  
Telescopic



**RH-779**  
**C640**  
Telescopic-Tilt

**ADAPTER**



**51640**  
**Adapter**  
SMA (male)/BNC (female) compatible with **CT510/CT710/CT890/G15/G18/G11V/D-200/ARCTIC**



**58610**  
**Adapter**  
SMA (female)/BNC (female) Compatible with **CT790/CT590/CT690/G10**



**RH-519**  
**C641**  
Super Flex



**RH-536**  
**C644**  
Super Flex



**SRH-536**  
**C646**  
Super Flex-SMA



**SRH-701**  
**C645**  
Super Flex-SMA

## WALKIE TALKIE, CB, OTHER ACCESSORIES

### BLUETOOTH, USB/LIGHTER RECHARGE

#### ADAPTERS AND WIRELESS HEADSETS



##### WA-DONGLE M C1199.02

Bluetooth adapter for Motorola 2-pin radio

##### WA-DONGLE K C1199.01

Bluetooth adapter for Kenwood 2-pin radio



##### WA-CB

##### C1276

Bluetooth mini-adapter for M-10, M-20, M-Mini



##### WA MIKE

##### C1263

Bluetooth microphone



##### WA21

##### C1201

Bluetooth headset microphone with PTT for WA-DONGLE/WA-CB



##### WA29

##### C1203

Bluetooth headset microphone with neckband and PTT for WA-DONGLE/WA-CB



##### WA31

##### C1202

Bluetooth microphone with air tube earpiece and PTT for WA-DONGLE/WA-CB

#### ADAPTERS, USB CHARGERS



##### MP-H 2USB

##### C1195

Dual USB DIN 12V adaptor (hooking handlebar). Input: DC 12V; Output: DC 5V/2A



##### ERCLP04U

Power supply kit with DIN adapter (BMW) for handlebar with dual USB port - Output: 5V/3.3A



##### MP-W ADAPTER

##### C1197

12V cigarette lighter/Din adapter (BMW)



##### KIT243

12V power supply with cigarette lighter socket and hook to fix it to the handlebar



##### C1348

##### Ua-Hella Micro 2A charger with USB SOCKET

Fitted with DIN, BMW-compatible socket



##### C1349

##### Ua-Hella A8 iPhone charger

Fitted with DIN, BMW-compatible socket

#### MIDLAND WIRELESS "WA" ACCESSORIES

The Midland Wireless "WA" range of accessories allows to use any Midland transceiver (fitted with 2 Pins) wireless. All devices have a rechargeable lithium battery, with USB cable for charging.

##### The WA series includes:

- **WA-DONGLE Bluetooth Adapter for 2-pin radio, including Kenwood/Motorola;**
- **Mini-WA-CB Bluetooth Adapter for M-10, M-20, M-Mini:** when connected to the portable or vehicular transceiver socket, you can choose the most suitable WA Series earphone according to your needs.
- **Bluetooth earphones WA21/WA31/WA29:** each earphone comes with a small PTT. With the WA Series earphones you can also pair any Bluetooth-equipped phone.
- **WA-MIKE Bluetooth Microphone:** communicating with your CB wirelessly (up to a distance of 10 meters)

## WALKIE TALKIE OVERVIEW TABLES

MODEL	XT10-XT30	XT50-XT50 ADVENTURE	XT60	XT70-XT 70 ADVENTURE
<b>Band</b>	PMR446	PMR446	PMR446-LPD (Dual-band)	PMR446-LPD (Dual-band)
<b>Channels</b>	8 + 8 pre-programmed	8 + 16 pre-programmed	8 + 16 pre-programmed 69 LPD	8 + 16 pre-programmed 69 LPD
<b>CTCSS and DCS</b>	38 CTCSS	38 CTCSS	38 CTCSS	38 CTCSS
<b>Vox</b>	1 sensitivity level	3 sensitivity levels	9 sensitivity levels	9 sensitivity levels
<b>Power supply</b>	3 AAA Ni-MH rechargeable batteries	3 AAA rechargeable batt. or 700mAh battery pack	3 AAA rechargeable batt. or 700mAh battery pack	3 AA rechargeable batteries or 1000mAh battery pack
<b>Autonomy 5/5/90</b>	Up to 5h (XT30)	Up to 12h	Up to 12h	Up to 17h
<b>Display</b>	Multifunction back-lit LCD	Multifunction back-lit LCD	Multifunction back-lit LCD	Multifunction back-lit LCD
<b>Transmission power</b>	500 mW ERP	500 mW ERP	500 mW ERP	500 mW ERP
<b>Operating temperature</b>	-20° +55°C	-20° +55°C	-20° +55°C	-20° +55°C
<b>Weight (without batteries)</b>	XT10: 73 g; XT30: 75 g	93 g	112 g	113 g
<b>Size (WxHxD)</b>	XT10: 48x85x30 mm XT30: 48x90x32 mm	54x103x33 mm	54x120x33 mm	58x120x33 mm
<b>Connections</b>	Audio accessories and USB socket (XT30)	Audio accessories and USB socket	Audio accessories and USB socket	Audio accessories and USB socket
<b>Accessory socket type</b>	2 pin (only XT30)	2 pin	2 pin	2 pin
<b>Compatible wall charger</b>	R73487	R73487	R73487	C1254

MODEL	MIDLAND G5 C	MIDLAND G7 PRO	MIDLAND G9 PRO	MIDLAND G10
<b>Band</b>	PMR446	PMR446-LPD (Dual-band)	PMR446-LPD (Dual-band)	PMR446
<b>Channels</b>	8 + 16 pre-programmed	8 PMR446/69 LPD	PMR446+16 progr/69 LPD	8+8 pre-programmed
<b>CTCSS and DCS</b>	38 CTCSS	38 CTCSS/104 DCS	38 CTCSS, 104 DCS	51 CTCSS, 83 DCS
<b>Vox</b>	3 sensitivity levels + talk back	6 sensitivity levels	3 sensitivity levels + talk back	-
<b>Power supply</b>	3 AAA Ni-MH rechargeable batteries	800mAh/1200mAh Li-Ion (opt) battery pack or 4 AA rechargeable batteries	4 AA 1800mAh rechargeable batteries or 4 AA alkaline batteries (opt)	Li-Ion 1200mAh battery pack
<b>Autonomy 5/5/90</b>	Up to 35h with alkaline batteries	Up to 18h with 800mAh battery pack	23h with 4 batteries (1800mAh)	16h
<b>Display</b>	Multifunction back-lit LCD	Multifunction back-lit LCD	Multifunction back-lit LCD	-
<b>Transmission power</b>	500 mW ERP	PMR446 500/10mW ERP (high/low) LPD 10mW	PMR446 500/10mW ERP (high/low) LPD 10mW	500mW ERP
<b>Operating temperature</b>	-20° +55°C	-20° +55°C	-20° +55°C	-20° +55°C
<b>Weight (without batteries)</b>	74 g	123 g	114 g	121 g
<b>Size (WxHxD)</b>	50x85x25 mm	58x122x34 mm	68x120x35mm	114x58x33 mm
<b>Connections</b>	Socket for audio accessories, charger	Socket for audio accessories, charger	Socket for audio accessories, charger	Socket for audio accessories
<b>Accessory socket type</b>	2 pin	2 pin	2 pin	2 pin Kenwood
<b>Compatible wall charger</b>	MW904	MW904	MW904	desktop charger only

## WALKIE TALKIE OVERVIEW TABLES

MODEL	MIDLAND G11V	MIDLAND G15	MIDLAND G18	MIDLAND GB 1-R
<b>Band</b>	PMR446	PMR446	PMR446	PMR446
<b>Channels</b>	8+8 pre-set sub-channels	8+8 pre-set channels	8+91 pre-set channels	8+91 pre-set channels
<b>CTCSS and DCS</b>	50 CTCSS, 105 DCS	50 CTCSS, 105 DCS	50 CTCSS, 105 DCS	50 CTCSS, 104 DCS
<b>Vox</b>	9 sensitivity levels	9 sensitivity levels	9 sensitivity levels	-
<b>Power supply</b>	1600mAh Li-Ion rechargeable battery pack	1600mAh Li-Ion rechargeable battery pack	1600mAh Li-Ion rechargeable battery pack	12Vdc +/-10%
<b>Autonomy 5/5/90</b>	22h	22h	22h	-
<b>Display</b>	-	-	Multifunction back-lit LCD	Multifunction back-lit LCD
<b>Transmission power</b>	500mW ERP	500mW ERP	500mW ERP (high/low)	≤ 500mW ERP
<b>Operating temperature</b>	-20° +55°C	-20° +55°C	-20° +55°C	-20° +55°C
<b>Weight (without batteries)</b>	209 g	192 g	240 g	220 g
<b>Size (WxHxD)</b>	112x58x34 mm	100x58x33 mm	113x56x38 mm	100x85x22 mm
<b>Connections</b>	Socket for audio accessories	Socket for audio accessories	Socket for audio accessories	Socket for external speaker
<b>Accessory socket type</b>	2 pin Kenwood	2 pin Motorola	2 pin Motorola	3.5 mm mono
<b>Compatible wall charger</b>	desktop charger only	desktop charger only	desktop charger only	-

MODEL	MIDLAND ONDA	BR01	BR02	BR03
<b>Band</b>	wireless radio mike 472÷474 MHz	PMR446	PMR446	PMR446
<b>Channels</b>	100	8 + 8 pre-programmed	8 + 8 pre-programmed	8+91 pre-programmed
<b>CTCSS and DCS</b>	-	50 CTCSS/232 DCS	38 CTCSS/104 DCS	50 CTCSS/104 DCS (N) 104 DCS (I)
<b>Vox</b>	-	-	-	10 sensitivity levels
<b>Power supply</b>	3,7V 650mAh Li-Ion rechargeable battery pack	2800mAh Li-Ion rechargeable battery pack	1800mAh Li-Ion rechargeable battery pack	2300 mAh rechargeable battery pack
<b>Autonomy 5/5/90</b>	Up to 8h	Up to 37h	Up to 24h	33h
<b>Display</b>	Multifunction back-lit LCD	-	-	Dynamic LED matrix
<b>Transmission power</b>	2mW ERP	500mW ERP	500mW ERP	500 mW erp
<b>Operating temperature</b>	-10° +45° C	-20° +55°C	-20° +55°C	-20 +55°
<b>Weight (battery included)</b>	58 g	101 g	126 g	83 g
<b>Size (WxHxD)</b>	42x86x16 mm	57x117x33 mm	57x117x33 mm	57x126x28mm
<b>Connections</b>	Socket for audio accessories, wall charger	Socket for audio accessories	Socket for audio accessories	Socket for audio accessories and USB
<b>Accessory socket type</b>	1 pin – 2,5 mm stereo	2 pin Kenwood	2 pin Kenwood	2 pin Kenwood
<b>Compatible wall charger</b>	MW905	USB cable	desktop charger only	C1254

**PMR446 equipment** operates on frequencies of up to 446 Mhz (8 channels) and have 500mW transmission power. **Dual band equipment** also operate on the LPD band of up to 433 Mhz (69 channels), with 10 mW transmission power; free use of channels 1 to 20. Both the PMR446 and the Dual band are subject to a general authorisation according to current legislation. Once purchased, two simple bureaucratic procedures must be fulfilled, an annual contribution of 12 euros paid, and a notice sent by recorded delivery to the Regional Inspectorate of the Ministry for Communication.

## VHF/UHF RADIO OVERVIEW TABLES

MODEL	CT590S	CT 890	CT990
Frequency	144-146MHz 430-440MHz	144-146MHz 430-440MHz	144-146MHz 430-440MHz
Operating temperature	-20°-+55°	-20°-+55°	-20°-+55°
Voltage supply	7.4V	7.4V	7.4V
Operating mode	Simplex or Semi-duplex	Full duplex	Simplex or Semi-duplex
Size (whitout antenna)	115x58x35,5mm	125x61x40mm	140x60x35mm
Weight (battery included)	230g	278g	310g
Antenna impedance	50Ω	50Ω	50Ω
Use cycle	5/5/90	5/5/90	5/5/90
<b>Transmitter</b>			
Frequency stability	±2.5PPM	±2.5PPM	±2.5PPM
Output power	VHF: 5W UHF:5W	VHF: 5W UHF:5W	10W (UHF/VHF)
Max. frequency deviation	5KHz	5KHz	5KHz
Audio distortion	≤ 3%	≤ 3%	≤ 3%
<b>Receiver</b>			
RF sensitivity	< 0.2μV	< 0.2μV	< 0.2μV
Audio distortion	≤ 3%	≤ 3%	≤ 3%
Audio response	300Hz ÷ 3KHz	300Hz ÷ 3KHz	300Hz ÷ 3KHz

MODEL	CT3000	CT2000	MODEL	ARCTIC
Frequency	144-146MHz 430-440MHz	144-146MHz 430-440MHz	Channels	57 international
Operating temperature	-20°-+55°	-20°-+55°	TX frequency coverage	156.025 - 157.425 MHz
Voltage supply	12.6V	12.6V	RX frequency coverage	156.300 - 162.000 MHz
Operating mode	Simplex or Semi-duplex	Simplex or Semi-duplex	Operating temperature	from -15°C to +55°C
Size (without antenna)	115x43x125mm	115x43x125mm	Size (WxHxD)	115 x 55 x 37mm
Weight (battery included)	809g	858g	Weight (transceiver only)	230 g
Antenna impedance	50Ω	50Ω	Accessory socket type	Motorola 2,5mm/3,5mm
Use cycle	5/5/90	5/5/90	Programmable	Via software (PRG-G15)
<b>Transmitter</b>			Water protection grade	IP67
Frequency stability	±2.5PPM	±2.5PPM	<b>Transmitter</b>	
Output power	25W (UHF/VHF)	25W (UHF/VHF)	Output power	1W or 5W selectable
Max. frequency deviation	5KHz	5KHz	Frequency stability	±2.5PPM
Audio distortion	≤ 3%	≤ 3%	Audio distortion	≤ 3%
<b>Receiver</b>			<b>Receiver</b>	
RF sensitivity	< 0.2μV	< 0.2μV	Sensitivity 20dB Sinad	0,3 μV
Audio distortion	≤ 3%	≤ 3%	Audio output power	300mW @ 10% THD
Audio response	300Hz ÷ 3KHz	300Hz ÷ 3KHz	Audio distortion	< 10%



*CAMERAS*

DASH CAM  
ACTION CAM

**MIDLAND<sup>®</sup>**

# BIKE GUARDIAN

## MOTORCYCLE CAMERA

NEW

Full HD  
1080



CYCLE  
RECORDING



WIDE ANGLE  
120°



RAINPROOF IP64



1920X1080P  
(27FPS)



RAINPROOF

**Bike Guardian**, the new motorcycle camera with FullHD resolution, designed and made to be another "eye" that records everything that happens while you are riding.

**Highly useful in the event of an accident to prove who was involved and who was to blame** Bike Guardian is the first motorcycle camera with continuous recording.

Connected to the motorcycle USB socket with the cable supplied, **it starts recording automatically when the bike is switched on and turns itself off when it is switched off.**

**Bike guardian** can be used also as a traditional **action cam** and, thanks to its integrated battery, allows up to 2 hours recording. Integrated microphone and speaker.

### RAINPROOF

Bike Guardian is able to withstand bad weather, mud and dust, ensuring a video without interruptions. Even the cable, which connects the camera to the bike socket, is rainproof.

### PACKAGING AND CODES

Camera, lock mount, handlebar mount, bi-adhesive flat mount, bi-adhesive curved mount, quick mount, screw, GO-PRO adaptor, strap mount, USB cable, USB rainproof cable, wrist belt.

code C1415



DASH CAM



# STREET GUARDIAN *FLAT*

## CAR CAMCORDER

NEW

Full HD  
1080



WI-FI



BLACK BOX



CYCLE  
RECORDING



WIDE ANGLE  
130°



MOTION SENSOR



PARKING FUNCTION



1920X1080P  
(30FPS)



12 MP



INCLUDES 2 ADHESIVE SUPPORTS



VERY THIN 92x69x33mm



REAL SIZE

DASH CAM

**Street Guardian Flat** is the thin **FullHD** camera with a discreet design for those who want to feel safe while driving, thanks to **video recordings complete with sounds**, without giving up a clean windscreen with complete vision.

**Integrated microphone and speaker.**

It connects to the cigarette lighter socket via the 12 V cable and can be easily installed on two cars, thanks to the adhesives included in the package.

### WI-FI

It is possible to use the Wi-fi to place the camera and set it up during the assembly/ installation on the car.

The Wi-fi also allows the review and download of the clips directly onto the smartphone without having to connect the camera to a PC (thus avoiding removal from the vehicle).

Recommended apps: FinalCam and LuckyCam.

### BLACK BOX AND MOTION DETECTION

The Black Box function makes the camera save and automatically protect the clips in case of an accident. The Motion Detection function allows the camera to start recording every time it detects a motion in the viewing range (requires the camera to be powered).

### PARKING FUNCTION

The parking function enables the camcorder to automatically start recording whenever it detects a collision. No more unpleasant surprises for your parked car!

### PACKAGING AND CODES

Camcorder, **2 adhesive supports**, cable with 12V cigarette lighter socket, USB cable to connect to a PC.

**code C1409**



# STREET GUARDIAN *GPS+*

## CAR CAMCORDER WITH BUILT-IN GPS

Full HD  
1080



BLACK BOX



CYCLE RECORDING



WIDE-ANGLE  
160°



MOTION DETECTION



WITH GPS



1920X1080P  
(30FPS)



12 MP



REAL SIZE

**Street Guardian GPS +** is the car camcorder with **built-in GPS** that identifies geographically every second of your route on a dedicated map, containing the **coordinates of all recordings**. Safety is therefore guaranteed not only by video and audio recordings (with integrated speaker and microphone) but also by monitoring the route. Quick to install, it is placed in the centre of the windscreen thanks to the handy suction cup and connects to the power supply with the 12 V cigarette lighter socket.

### BLACK BOX AND MOTION DETECTION

Like the other Street Guardian models, it is equipped with Black Box technology, which automatically saves and protects videos in the event of an accident and with Motion Detection, that starts recording any external movement within the camera range.

### POSITION SIGNALLING

The built-in GPS indicates the location where you are, the speed you are going to and follows you step by step along the way.

### PACKAGING AND CODES

Camcorder, suction cup mount with GPS, 12 V cigarette lighter socket, USB cable for PC connection.  
**code C1284.01**



# STREET GUARDIAN *DUAL*

## DUAL CAR CAMCORDER

NEW

Full HD  
1080



BLACK BOX



NIGHT VISION  
4 IR LED



CYCLE  
RECORDING



WIDE ANGLE  
150° OUT+120° IN



MOTION DETECTOR  
(OUT)



WITH GPS



1920X1080P (OUT)  
1920X1080P (IN)



12 MP



REAL SIZE

**TWO CAMERAS RECORDING WHAT IS HAPPENING IN AND OUT THE CAR.  
IDEAL FOR TAXIS AND PUBLIC TRANSPORT.**

The **Street Guardian Dual** is double; in fact it has **two cameras**, to film what is happening inside and outside the car. Designed to record automatically even without light, it is equipped with Night Vision technology and 4 infrared LEDs (the latter for internal shooting). **Integrated microphone and speaker.**

### BLACK BOX AND MOTION DETECTION

In case of an accident, the Black Box function automatically saves the videos. The Motion Detection function uses the vision range to start recording any movements outside the car.

### GPS

The built-in GPS indicates the location where you are and follows you step by step along the way.

### PACKAGING AND CODES

Camcorder, suction cup mount with GPS, 12V cigarette lighter socket, USB cable for PC connection.

**code C1285**



DASH CAM

# TRUCK GUARDIAN *WIRELESS*

## TRUCK AND CARAVAN VIDEO-SURVEILLANCE SYSTEM



WIRELESS UP TO 150M



IP67 (CAMERA)



7" MONITOR



NIGHT VISION 12 IR LED



CYCLE RECORDING



WIDE-ANGLE 120°



2/24V DUAL SUPPLY



REMOTE CONTROL



VIDEO RESOL. 800X480P (60FPS)

CONNECT UP TO 4 CAMERAS

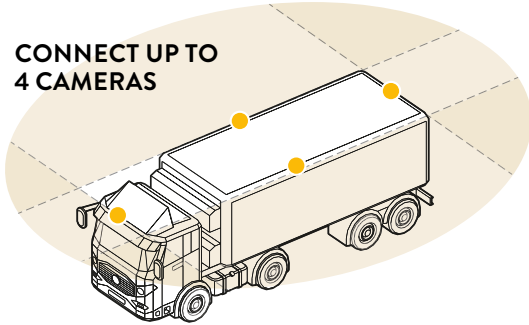

SYSTEM SUITABLE FOR VEHICLES FOR THE TRANSPORT OF ANIMALS



**Truck Guardian Wireless** is the camera for trucks and caravans, designed and made to help during manoeuvres and to record what is happening around you. Highly useful when reversing and in the event of an accident to prove causes and responsibilities.

### WIRELESS

Wireless technology makes installation extremely easy, as camera and monitor do not need to be connected. Just find a 12 or 24V power source. If you want to add an additional camera (up to 4), simply power it and it will automatically be coupled to the monitor.

### 7" MONITOR AND REMOTE CONTROL

The large wireless monitor with recorder located inside the truck cabin, is equipped with a remote control, to control the monitor functions remotely.

### NIGHT VISION THAT IS NOT AFRAID OF BAD WEATHER

The water resistant (IP67) video camera has a 120° viewing angle and it is equipped with 12 infrared LEDs for night viewing, which light up automatically

### CYCLIC RECORDING

Cyclic recording allows to record continuously from one to four cameras even simultaneously.

### PACKAGING AND CODES

#### Truck Guardian Wireless

Monitor, camera, power cable with cigarette lighter socket (for monitor), power cable (for video camera), 3 Wi-Fi antennas (2 for monitor, 1 for video camera), remote control, sunshade frame, mounting support.

code **C1331**

#### Additional wireless truck camera

Camera, power cable, Wi-Fi antenna.

code **C1332**



## CAR/BIKE CAMERAS

# OVERVIEW

MODEL	BIKE GUARDIAN	STREET GUARDIAN DUAL	STREET GUARDIAN FLAT
Resolution	1920x1080p (27fps)	Front 1920x1080p Back: 1920x1080p	1920x1080p (30fps)
Sensor	Sony 2 MP	4 MP/2 MP	2 MP
Aspect Ratio	16:9	16:9	16:9
Format	MOV	MP4	MP4
Lens	-	7 elements - 5 elements	6 elements
Lens angle	120°	160° - 120°	130°
Sd Card	128 GB (Class 10)	128 GB	32 GB
Battery	680mAh up to 180'	Only for finalizing video files	Only for finalizing video files
Wi-Fi	No	No	Yes
Photo	2 MP	12 MP	12 MP
Tripod mount	Yes	No	No
Weight	78g	87g	72g
Dimensions (WxHxD)	86mm Ø27mm	102x42x42mm	92x69x33mm
Operating systems	Win XP, SP2, Vista 7&8, Mac OSX 10.4+	Win XP, SP2, Vista 7&8, Mac OSX 10.4+	Win XP, SP2, Vista 7&8, Mac OSX 10.4+

MODEL	STREET GUARDIAN GPS+	TRUCK GUARDIAN WIRELESS	
		Monitor	Camera
Resolution	1920x1080p	800x480	756x504
Sensor	3 MP	-	CMOS
Aspect Ratio	16:9	16:9	16:9
Format	MOV	-	-
Lens	6 elements	-	-
Lens angle	160°	-	120°
Sd Card	64 GB	128 GB	-
Battery	Only for finalizing video files	-	-
Wi-Fi	No	2.4 GHz encrypted transmission	2.4 GHz encrypted transmission
Photo	12 MP	-	-
Tripod mount	No	Support bracket	Support bracket
Weight	70g	430g	500g
Dimensions (WxHxD)	88x48x34mm	180x125x25mm	85x50x40mm
Operating systems	Win XP, SP2, Vista 7&8, Mac OSX 10.4+	Win XP, SP2, Vista 7&8, Mac OSX 10.4+	

# MIDLAND H9

## THE NEW 4K ACTION CAM

NEW

4K HDR  
ULTRA HD



WI-FI



SUBMERSIBLE  
CASE 30M



2" LCD DISPLAY



VIDEO/PHOTO



TIME LAPSE PHOTO



TIME LAPSE VIDEO



WIDE ANGLE  
170°



**H9** is an extra-slim camera with a compact design and excellent resolution: **Real 4K!** **H9** can record films with resolution up to 4K@30fps; moreover the built-in chipset Ambarella guarantees the best ever videos! Thanks to the Panasonic sensor, H9 can take high quality photos up to 14MP.

### DISPLAY LCD 2" INTEGRATED

H9 has an integrated display for framing and easily adjusting settings as well as reproducing photos and videos.

### TIME LAPSE

It produces exceptional videos with advanced features: Photo Time Lapse (sequence of photos at a set time interval) and Time Lapse Video (creates accelerated videos).

### REMOTE CONTROL

It is equipped with a 2.4 Ghz wrist wireless remote control, its buttons enable the switch on and off of the camera and to take videos and photos.

### WATERPROOF CASE 30M

The submersible case supplied protects the action cam from water up to a depth of 30 meters, but also from mud and dust.

### WI-FI

Thanks to the built-in wi-fi and high-performance chipset, H9 connects to smartphones and tablets to watch again and share films and photos with the dedicated "Midland H9" App (iOS and Android).

### PACKAGING AND CODES

Camera, 30m waterproof case, remote control, 3.7V/1000mAh Li-ion battery pack, frame (to be used without case), curved base, flat base, 2 quick-release couplings, 90° support, handlebar support, clamp, USB cable, screw, screw coupling.  
**code C1405**



# MIDLAND H5+

## UHD BEST SELLER



WI-FI



SUBMERSIBLE CASE 30M



2" LCD DISPLAY



VIDEO/PHOTO



CAR DVR



TIME LAPSE



WIDE ANGLE 140°



ALL ACCESSORIES IN THE PACKAGE



The very small dimensions, weight - only 60 gr. - practicality and 3840x2160@25fps resolution make H5+ perfect for the needs of all athletes and outdoor enthusiasts.

### BUILT-IN 2" LCD DISPLAY

Midland H5+ introduces the integrated display for framing, adjusting easily the settings and playing video and photos.

### CAR DVR FUNCTION

Fitted with Cycle recording, it can be easily installed in the car and record continuously what is happening while you drive.

### TIME LAPSE

Produces exceptional videos with advanced Time Lapse function (photo sequence at a time interval).

### WIDE-ANGLE

Fitted with 140° wide-angle lens for excellent videos.

### 30M SUBMERSIBLE CASE

The submersible case supplied protects the action cam from water up to a depth of 30 meters, but also from mud and dust.

### WI-FI

Midland H5+ thanks to built-in wi-fi connects to smartphones and tablets to see, watch again, and share movies and photos with the dedicated App "Ez i Cam" (iOS and Android).

### PACKAGING AND CODES

Camera, submersible case 30 m, coloured front, 1050 mAh Li-ion battery pack, USB cable and 20 elements to be combined to create the mounting solution that best suits your needs (ex: helmet support, bicycle helmet, etc)

code **C1208.02**



# MIDLAND H360 SMART

## THE 360° SOCIAL ACTION CAM

Full HD  
1080



ROUNDIE VIEW



VIRTUAL REALITY  
READY



ANDROID (OTG)



**Live a 360° social experience** with the action cam that, via built-in USB, connects directly to your smartphone and allows you to film your best moments, sharing them in real time. 360° cameras are the vanguard among the latest action cams and allow you to shoot in full immersion and share your favorite moments. **Live Facebook and YouTube with your smartphone with only 40mm more.**

### 360° FULL HD FOR BEAUTIFUL VIDEOS

With a maximum resolution of 2048x1024@25fps which guarantees you excellent quality videos. It is necessary to download the dedicated «EZ-PANO» APP, available on Play Store.

H360 SMART is compatible with Android phones with USB OTG (On-The-Go) function. Photos and videos in Sphere and Little Planet modes.

### FEATURES

- Weight: 36g, diameter: 40mm
- Compatible Android models: **Samsung** Note 4/Note 5/Note 8/J5/J7/S6/S7/ S7 Edge/ S8/S8 Plus/A8/A9/ C5 Pro/C7 Pro/C9 Pro. **LG** G3/G4/G5/G6/V10/V20/V30/ Stylo 3Plus. **Sony** Z3/Z5/ XZ/ XZs/ XA1/ XA. **Huawei** Honor 6/Honor 7/Mate S/ Mate 8/Mate 9/P8/P8 Lite/P9/P10. **HTC** M8et/M8t/A9W/10/One M9+/One M9/ One M8/U11. **Asus** ZenFone 3/ZenFone Zoom/ZenFone Selfie/ZE553KL/ZC521TL/ ZE552KL/ZU680KL/Zs550KL/Zs570KL/

X005/X008. **Google** Pixel XL/Pixel/Nexus 5X/Nexus 6P. **ZTE** ZMAX Pro/BladeV8/V7 Max/A910 ZTE7/ZTE7 Max. **Motorola** Moto Z Droid/Moto Z Force Droid/G Plus/G. **Xiaomi** Mi: Mi3S/Mi4/Mi5/Mi5S/Mi Max / Note 1/Note 3/Note 4. **Oppo** R9/R9s/R11. **Nubia** Z11. **Lenovo** ZUK. **Meizu** M1 Metal.

Download the updated list from: [midlandeurope.com](http://midlandeurope.com)

### PACKAGING AND CODES

H360 SMART videocamera, Micro USB/Type C connector.  
**code C1338**



CAMERAS

ACTION CAM ACCESSORIES

KIT

H5



**ACC-H5**  
**C1245**  
Accessory set

H3



**ACC-H3**  
**C1244**  
Accessory set

REMOTE CONTROLS

H9



**R01487**  
Remote control suitable for H9

NEW

H7  
H7+



**RC-H7/H7+**  
**C1248**  
Remote control suitable for H7, H7+

H180  
H360



**RC-H180**  
**C1320**  
Remote control suitable for H180, compatible with H360

SURFACE

H  
SERIES  
GO PRO



**TURNABLE HOOK**  
**360°**  
**C1268**  
Rotating hook mount 360° for base with double-sided tape

GO PRO

H3  
H5/H5+  
H7/H7+  
H9  
GOPRO



**BASIC**  
**C1273**  
Base fixing system (4 pieces)

GO PRO

XTC400  
XTC450



**BASIC**  
**C1108**  
Base fixing system (4 pieces)

XTC400  
XTC450



**MINISPIDER**  
**C1109**  
Small base with 3M adhesive and 45° slide

XTC400  
XTC450



**SPIDER**  
**C1110**  
Large base with 3M adhesive and 45° slide for surf/snowboard

XTC280  
XTC270



**HELMET MOUNT**  
**C990**  
Bi-adhesive helmet mount.

XTC280  
XTC270



**SURF SNOW BOARD MOUNT**  
**C1038**  
270° Adjustable ABS and stainless steel mount with safety device to be fixed to a surfboard or snowboard

WEARABLE

XTC400  
XTC450



**BELT MOUNT**  
**C1111**  
Belt mount

XTC400  
XTC450



**VENTED HELMET MOUNT**  
**C1112**  
Bicycle helmet mount

XTC400  
XTC450



**HEAD STRAP MOUNT**  
**C1113**  
Headband mount

XTC400  
XTC450



**GOGGLES MOUNT**  
**C1114**  
Mount for goggles (ski, motocross)

XTC280  
XTC270



**GOGGLES MOUNT**  
**C989**  
Mount for goggles (ski, motocross)

ALL\*



**CAP MOUNT**  
**C1012**  
Cap mount

## CAMERAS

XTC280  
XTC270



**HEAD STRAP MOUNT**  
C1040  
Headband mount

ALL\*



**UNIVERSAL RIFLE MOUNT**  
C1064.01  
Universal mount for rifles

XTC280  
XTC270



**VENTED HELMET MOUNT**  
C991  
Universal Velcro band for bicycle helmet, rucksack, etc.

ALL\*



**BOW MOUNT**  
C1068  
Bow mount

**TREE MOUNT**  
C1062  
Tree mount

## VEHICLE

XTC400  
XTC450



**HANDLEBAR MOUNT**  
C1117  
Mount for handlebars

ALL\*



**SUCTION CAP MOUNT** C980.01  
Suction mount for cars and motorcycles for stable recording on a vehicle, ideal for smooth (bodywork) and rough surfaces (dashboard)

ALL\*



**HANDLEBAR MOUNT**  
C992  
Mount for handlebars and tubes

## POD

ALL\*



**XT-POD**  
C1116  
Multicam Monopod – Aluminum body (18cm)

GO PRO

ALL\*



**XT-POD 2S**  
C1116.01  
Telescopic multicam 2-section Monopod 100% Carbon fiber (80cm)

GO PRO

ALL\*



**XT-POD 3S**  
C1116.02  
Telescopic multicam 3-section Monopod 100% Carbon fiber (112cm)

GO PRO

## PROFESSIONAL/RAM

ALL\*



**RAM ROLL BAR MOUNT**  
C1042  
Professional mount for tubular handlebar with a diameter from 1 to 3 cm

ALL\*



**RAM MOTO QUAD MOUNT**  
C1052  
Professional mount suitable for all vehicles with tubes with a diameter from 3 to 6 cm

## ADAPTERS

H  
SERIES,  
GO PRO



**TRIPOD MOUNT**  
C1270  
Adapter for GOPRO. *This adapter allows to use all screw-type accessories with H series action cams*

GO PRO

XTC400  
XTC450



**TRIPOD MOUNT**  
C1120  
Side adapter to transform any screw mount into a side attachment

## TACTICAL/WEAPONS

XTC400  
XTC450



**PICATINNY MOUNT**  
C1118  
Mount for rifles and guns with Picatinny Rail

XTC280  
XTC270



**TRIPOD MOUNT**  
R73161  
Side adapter to transform any screw mount into a side attachment

XTC280  
XTC270



**PICATINNY MOUNT**  
C1039  
Mount for rifles and guns with Picatinny Rail

XTC  
SERIES  
H180  
H360



**GOPRO ADAPTER**  
101854  
This adapter allows the use of GOPRO mounts with XTC MIDLAND cameras

## CAMERAS

### SUBMERSIBLE CASES/LENS KIT

H9		<b>WPC-H9</b> <b>R01488</b> Submersible case 30 m	<b>NEW</b>
H5+		<b>WPC-H5+</b> <b>C1335</b> Submersible case 30 m	
H5 H3		<b>WPC-H5</b> <b>C1247</b> Submersible case 30 m	
H7+		<b>WPC-H7+</b> <b>C1336</b> Submersible case 30 m	
H360		<b>WPC-H360</b> <b>C1319</b> Submersible case 30 m	
H180		<b>R74447</b> Submersible case 30 m	
XTC400 XTC450		<b>CC-XTC400</b> <b>C1121</b> Submersible case 85 m	
XTC300		<b>CC-XTC300</b> <b>C1031</b> Case with flat lens, up to 60 m	
XTC280 XTC270		<b>CC-XTC280</b> <b>C976.01</b> Case with flat lens, up to 60 m	

### XTC SERIES



**ANTI CONDENSATION INSERTS**  
**C1171**  
18 inserts and one humidity indicator

### XTC300



**LENS KIT C1074**  
camera lens, spherical lens, flat lens  
60 m of case and seals

### XTC300



**FLAT LENS**  
**R73453**  
60 m flat lens

### BATTERIES

#### H3 H5 H5+ H9



**PB-H5**  
**C1246**  
900 mAh 3,7V Li-Ion battery pack

#### H7+

**R74538**  
1050 mAh Li-Ion battery pack

#### H180

**R74537**  
1000 mAh Li-Ion battery pack

#### XTC400 XTC450

**BATTERY**  
**C1124**  
1700 mAh 3,7V Li-Ion battery pack

#### XTC280 XTC270

**BATTERY**  
**R72963**  
900 mAh Li-Ion battery pack

\* Compatible with action cam H series using Tripod Mount Adapter C1270

## OVERVIEW

MODEL	H9	H5+	H360 SMART
Resolution	4K (30fps)	4K (25fps) - 2,7K(30fps) - 1920 x 1080p(60fps)	2048x1024 (25fps)
Sensor	Panasonic 14 MP	4 Mp	2 Mp
Aspect Ratio	16:9	16:9	2:1
Format	MP4	MOV	H.264 - MP4
Lens	7 elements	-	6 elements
Lens angle	170°	140°	220° x 2
Sd Card	64 GB	Up to 32 GB	-
Battery	1050 mAh, up to 90 minutes	Li-Ion 1050 mAh, up to 90 minutes	-
Wi-Fi	Yes	Yes	-
Photo	14 MP	12 Mp (interpolated)	2 Mp
Tripod mount	No	No	-
Weight	65	58g	36g
Dimensions (WxHxD)	58x41x30mm	59,3x41x30mm	Ø 41
Operating systems	Win XP, SP2, Vista 7&8, Mac OSX 10.4+	Win XP, SP2, Vista 7&8, Mac OSX 10.4+	Android 5.0 or superior, OTG Function support

*JUMP STARTER & POWER BANK*



**MIDLAND®**

# ENERJUMP MINI

## JUMP STARTER 12V - POWER BANK



BATTERY CABLES



USB PORT



CURRENT PEAK 400A



CAPACITY 6000MAH



100L LED FLASHLIGHT



BATTERY LEVEL



### SMART JUMP START SYSTEM: WITH INTELLIGENT CLAMPS

Your energy reserve when you don't have the Battery you deserve.

**Jump Starter for cars, bikes, ATV, etc.:**

Enerjump Mini is small but powerful enough to start vehicles fitted with a 12V battery (3000cc petrol / 2000cc diesel).

**The power bank suitable for all devices with a USB plug:** Enerjump Mini has 1 USB socket to recharge smartphones, tablets, cameras, MP3 readers, etc.

Thanks to its capacity (6000mAh) it recharges your iPhone up to 2 times.

### SMART JUMP START SYSTEM™

Enerjump Mini is fitted with Smart Jump Start System™ that allows automatic detection of the battery charge, protection against short circuits and polarity reversal.



17x8.1x1.7 cm: EXTRA THIN!

### LED TORCH AND CHARGE INDICATOR

Enerjump is fitted with a powerful LED 100L torch and charge indicator (4 signaling levels).

### PACKAGING AND CODES

Enerjump Mini, starting clamps with "Smart jump start system", USB/microUSB cable. code C1355

# ENERJUMP

## JUMP STARTER 12V - POWER BANK



BATTERY CABLES



USB PORT



CURRENT PEAK 400A



CAPACITY 8000MAH



LED FLASHLIGHT



BATTERY LEVEL



**The power bank suitable for all devices with a USB plug:** Enerjump has 1 USB socket to recharge smartphones, tablets, cameras, MP3 readers, etc. Thanks to its capacity (8000mAh) it recharges your iPhone up to 3 times. Enerjump starts vehicles with 12 V battery (3000cc petrol / 2000 cc diesel).

### LED TORCH AND CHARGE INDICATOR

Enerjump is fitted with a powerful LED torch and charge indicator. In an emergency also a luminous SOS can be launched.



13x7.5x2.5cm: IT FITS IN YOUR POCKET!

### PACKAGING AND CODES

Enerjump, starting clamps, car 12V battery, wall supply, USB/microUSB cable, soft case. code C1184

# ENERJUMP WORK

## JUMP STARTER 12V - POWER BANK

WATCH THE VIDEO ON  
YOUTUBE  
**ON THE ROAD WITH  
ENERJUMP**



BATTERY  
CABLES



USB  
PORT



CURRENT PEAK  
600A



CAPACITY  
18000MAH



LED  
FLASHLIGHT



BATTERY  
LEVEL



SIZE: 23x8,7x2,7cm

The power bank and jump starter for **vans, Off-road vehicles**, etc...  
**Enerjump Work** is ideal for work vehicles with 12V battery (**5000cc petrol / 3000cc diesel**).

### IT SIMULTANEOUSLY RECHARGES 2 DEVICES WITH USB

Enerjump Work has 2 USB sockets that simultaneously recharge portable devices, such as smartphones, tablets, cameras, MP3 readers, etc. Thanks to its capacity (18000mAh) it recharges your iPhone up to 6 times. Enerjump Work also has a 12 V socket to supply fridges and other car accessories and a 19V socket to recharge your laptop. Enerjump Work is fitted with a powerful LED torch and charge indicator. In an emergency also a luminous SOS can be launched.

### SMART JUMP START SYSTEM™

Enerjump Work is fitted with Smart Jump Start System™ that allows automatic detection of the battery charge, protection against short circuits and polarity reversal.

### PACKAGING AND CODES

Enerjump Work, starting clamps with Smart Jump Start System™, car 12V battery, wall supply, USB/microUSB cable, Notebook connector set, semirigid case.  
**code C1184.01**



# ER300

## EMERGENCY POWER BANK



AM/FM RADIO



POWER SOURCE  
DYNAMO CRANK



POWER SOURCE  
SOLAR PANEL



LED  
FLASHLIGHT



CHARGE  
THE DEVICE  
WITH USB



BATTERY  
UP TO 25 HOURS



DOG WHISTLE FOR  
RESCUE TEAMS



AM/FM Radio



Dynamo recharge



Charge the device with USB port

SOLAR PANEL



ER300 is a powerful powerbank capable of recharging portable devices and an **emergency device** equipped with an AM/FM receiver, designed for emergency situations, disasters and safety in which keeping in touch is essential. ER300 is a versatile solution also for everyday use, for outdoor activities, camping or in leisure time. Rechargeable via dynamo, solar panel, batteries and USB socket. With ultrasonic call for dogs, torch.

**Frequency:** 531-1629KHz (AM)  
87,5-108MHz (FM)

**Colour:** Red/Black

### FEATURES

- 4 power sources: dynamo crank, solar panel, internal Li-Ion 2000 mAh battery pack or simply rechargeable batteries
- It charges external electronic devices with USB port
- Power bank with long life rechargeable battery 3,7Vdc Li-Ion 2000 mAh, lasting up to 25 hours of normal use
- It also works with 6 AA battery (not included)
- Powerful flashlight with Cree® led 130L\*
- SOS Morse code flashlight beacon
- Ultrasonic dog whistle useful for rescue teams
- AM/FM radio
- Digital clock
- Headphone jack
- Telescopic antenna
- Wide, bright LCD with backlight

### PACKAGING AND CODES

Radio, 2000 mAh Li-Ion battery pack, USB/micro USB cable  
**code C1173**

\* Cree® is a registered trademark of Cree Inc

*INTERCOM*



**MIDLAND®**



# 13 YEARS OF INTERCOM COMMUNICATION.

Since 2006 Midland has specialized in intercom devices improving motorcycle communication. After the launch of the revolutionary firmware MWE in 2018, which erases background noise, Midland introduces an important **innovation in 2019**.



*MIDLAND MESH CONFERENCE*

**Midland Mesh Conference™** is the technology that allows a perfect intercom communication in full duplex up to 10 people at the same time.

Each user can exit from the conversation and join it again whenever he desires, through an automatic connection with the complete group without “chains”.



## BT MESH.

THE INTERCOM WITH MMC™ TECHNOLOGY





**Communication up to 10 people** in full duplex.  
Up to 1.4 km.

Compatible with every Midland model via Bluetooth.

Compatible with other brand models through the **Universal Intercom function**.

# MIDLAND INTERCOM RANGE



FEATURES	BT MESH	BT NEXT PRO UR	BTX2 PRO
 <b>Mesh Full duplex</b>	Up to 10 people	-	-
<b>Conference</b>	-	4 bikes (8 people)	4 people
 <b>One to One Midland</b>	3 people	4 people	4 people
<b>One to One Universal Intercom</b>	1 person	2 people	1 person
 <b>Unlimited communication with BTT Button</b>	-	Yes	-
 <b>Range</b>	1400 m	1600 m	1000 m
 <b>Music share</b>	Yes	Yes	Yes
 <b>Emergency stop light</b>	-	Yes	Yes
 <b>FM Radio</b>	Yes	Yes	Yes
 <b>Mobile connection</b>	2	2	2
 <b>Waterproof</b>	IPX6	IPX6	IPX6
 <b>BT SET APP</b>	Yes	Yes	Yes
 <b>Voice messages</b>	Yes	Yes	Yes
 <b>Stereo background</b>	Yes	Yes	-
 <b>Helmets compatibility</b>	All	All	All
 <b>Battery life</b>	23 h	23 h	23 h
 <b>AGC Automatic volume control</b>	Yes	Yes	Yes
 <b>Single pack code</b>	C1412	C1222.04	C1231.02
 <b>Twin pack code</b>	C1412.01	C1222.05	C1231.03

DISCOVER ALL THE FEATURES OF OUR INTERCOMS AT  
**WWW.MIDLANDEUROPE.COM**



**BTX1 PRO**

**BTX1 FM PLUS**

**BT GO UNI**

**BT GO JET**

-	-	-	-
-	-	-	-
2 people	2 people	2 people	2 people
1 person	1 person	-	-
-	-	-	-
300 m	10 m	200 m	200 m
Yes	-	-	-
Yes	-	-	-
Yes	Yes	-	-
2	2	1	1
IPX6	IPX4	IPX6	IPX6
Yes	Yes	-	-
Yes	Yes	Yes	Yes
-	-	-	-
All	All	modular and integral helmets	Jet helmets
23 h	10 h	8 h	8 h
Yes	Yes	-	-
C1230.02	C1142.04	C1310.01	C1310
C1230.03	C1142.05	-	-

# MIDLAND®

ANNIVERSARY | 60 YEARS  
1959-2019

**MIDLAND**, born in 1959 in a small factory in Kansas City, is today world leader in the radiocommunication and consumer electronics.

**CTE International** became part of Midland history in the 1970s thanks to an European commercial strategy and, in the 1990s, by acquiring a significant share of the American company, contributing to the brand success, all over the world.

A Group composed by over **15 branches and strategic partners**, and a network in over 90 countries, all under the leadership of the **Italian Headquarters**, based in Reggio Emilia.

It is the heart of Research and Development Department that has been carrying on the mission with a strong commitment:

*“To realize a world where communicating is easy, fun and approachable to everybody”.*

Midland produces with passion products of quality, technologically innovative. Products that respond to the real need of all of us: to communicate.

**A success that has been going on for 60 years.**



## A HISTORY OF INNOVATION

1977

1<sup>ST</sup> APPROVED CB  
ON THE EUROPEAN MARKET

1998

1<sup>ST</sup> LPD WALKIE-TALKIE  
DESIGNED IN THE WORLD

2008

1<sup>ST</sup> BIKE TO BIKE  
INTERCOM IN THE WORLD

2013

1<sup>ST</sup> WI-FI ACTION CAM WITH  
REMOTE CONTROL

2018

1<sup>ST</sup> DIGITAL  
CB MIKE

# MIDLAND GROUP

USA  
**Midland Radio Corporation**  
Kansas City  
www.midlandusa.com

ITALY  
**Cte International**  
Reggio Emilia  
www.midlandeurope.com

Germany  
**Alan Electronics**  
Dreieich  
info@alan-electronics.de  
www.alan-electronics.de

Spain  
**Midland Iberia**  
Barcelona  
info@alan.es  
www.midland.es

France  
**Alan France**  
Ennery  
infos@alanfrance.fr  
www.alan-midland.fr

Bulgaria  
**Alan Telecommunication**  
Sofia  
alan.bulgaria@me.com  
www.midlandeurope.com

Poland  
**Alan Telekomunikacja**  
Warsaw  
info@alan.pl  
www.alan.pl

Romania  
**SC Online Shop**  
Piatra Neamt  
comenzi@statie-radio.ro  
www.statie-radio.ro

Russia  
**Alan-Sviaz**  
Moscow  
info@midland.ru  
www.midland.ru

Japan  
**Links Of Japan**  
Osaka  
info@midlandradio.jp  
www.midlandradio.jp

United Kingdom  
**Alan - Nevada UK**  
Portsmouth  
sales@nevada.co.uk  
www.nevadaradio.co.uk

Turkey  
**DNS**  
İstanbul  
ocagman@dnsticaret.com  
www.dnsonlineshop.com

Greece  
**Cobra Center Ltd**  
Athens  
techdep@cobra-center.gr  
www.cobra-center.gr

Australia  
**AudioXtra International**  
Sydney  
info@audioxtra.com.au  
www.audioxtra.com.au

Israel  
**SHCHORI Cellular Communication**  
Tel-Aviv  
info@midland.co.il  
www.midland.co.il

## WARRANTY

All our products are covered by a 24-month warranty, as long as they are sent to our **Technical Service Centres** together with the tax receipt. Contact our **Authorised Retailer** who will tell you where the nearest **Service Centre** is located.

**N.B.** we accept returns of material only if carriage paid and with the **Sales Dept's** (0522 509411), **Customer Technical Service Dept's** (0522 509535) or **Intercoms Dept.'s** (0522 509446) **prior authorization**. The lack of said authorization will cause the products to be immediately returned to the sender.

## CERTIFICATIONS

**ETSI:** CTE International is a credited member of ETSI - the European Telecommunications Standards Institute - which it helps define standardised technical specifications for telecommunication products and services.

**ISO 9001 2015:** for the design, production and installation of telecommunication systems and equipment for industrial, military, civil, marine and consumer use.

**ANITEC-ASSINFORM:** CTE International is part of the ANIE Federation research and innovation commission, a member of Confindustria and represents the electro-technical and electronic businesses operating in Italy.



Member of Confindustria and Confindustria Digitale Italian Association for Information and Communication Technology

**Photo: Enrico Coppola - Art Direction: Roberta Saccon**

We would like to thank: Vittorio Spinelli, called lo Zingaro.

This catalogue replaces and cancels the previous ones.

We reserve the right to modify and improve at any time and without notice the technical and aesthetic features of the equipment. All trademarks shown belong to their respective owners.

## CTE INTERNATIONAL srl

Via R. Sevardi 7 - 42124 Reggio Emilia - Italy  
Tel. +39 0522 509411 • info@midlandeuropa.com  
[www.midlandeuropa.com](http://www.midlandeuropa.com)

Download this catalogue



Follow us:

 @Midland World

 @Midland World

 Midland World

Dealer

