



Instruction Manual

AE 201 S

10-Meter AM/FM/SSB Transceiver

Downloaded from www.cbradio.nl

Content	Page
Specifications	2
Description	3
Receiver	3
Transmitter	3
Power Supply	3
Operating Control and Features	4
Top Panel Features	4
Side and Back Panel Features	5
Description of Features	6
Front Panel Features	6
Display Panel Features	10
Batter Pack Instructions	12
Batter Pack Instructions (Con't)	13
Operating Procedure	14
Operating Procedure to Transmit	14
Operation Procedure to Receive	14
Receiving SSB Signals	15
Receiving SSB Signals (Con't)	16

SPECIFICATIONS

GENERAL

Frequency Range.....	28.000 to 29.699 MHz
Frequency Control.....	Phase Lock Loop (PLL) Synthesizer
Frequency Stability.....	± 0.001 %
Operating Temperature.....	-5 degree F to +110 degree C
Power Source.....	7.2V DC to 13.8V DC
Antenna Impedance.....	50 ohm
Dimension.....	63W x 169H x 39D (mm)
Weight.....	0.4 Kg
Antenna Connection.....	BNC

TRANSCEIVER

Power Output.....	AM/FM @ 12.0V High:4.0W Low: 1.0W SSB @ 12.0V High: 6.0W - 7.0W PEP
Modulation.....	Amplitude Modulation
Current Drain.....	Less than 1200mA
Frequency Tolerance.....	± 400Hz max

RECEIVER

Sensitivity.....	AM/FM 1.0uV for 10dB S/N SSB 0.8uV for 10dB S/N
Image Rejection.....	Greater than 70dB
Audio Output Power.....	500mW
Frequency Response.....	300-3000Hz
Standby Current.....	50mA w/o battery save mode

* Requires Ni-Cad "AA" batteries

DESCRIPTION

This model is an ALL-TRANSISTORIZED 2-way radio transceiver. A frequency synthesizer circuit provides PLL controlled transmitter and receive in the amateur band, engineered for trouble-free performance. Your transceiver uses heat resistant transistors in all critical areas. Current drain on 12 volts DC is exceptionally low.

RECEIVER

The receiver is a sensitive and highly selective dual-conversion superheterodyne type providing PLL controlled operation on all CB channels. A X-TAL filter providing sharp selectivity and high adjacent channel rejection. As a result, transmissions on adjacent channels cause minimum interference.

TRANSMITTER

The transmitter offers PLL controlled operation on all CB channels, minimum DC power input to the final RF with average modulation capabilities is possible by the use of high-efficiency Transistors and low loss components, wiring, and mounting boards. The legal limit of power for this service is provided.

POWER SUPPLY

The transceiver is ready for connection to a 12 volt DC, negative ground system. DC power is provided to the transceiver by means a fused power lead with the cigarette lighter DC power adaptor from car battery or battery pack.

WARNING : Do not attempt to use DC power lead with standard penlight carbon cells or alkaline or alkaline batteries.

<p>WARNING ! CONTINUOUS OPERATION OF THIS TRANSMITTER WITH GREATER THAN 4:1 VSWR ANTENNA MISMATCH MAY RESULT IN RF AMPLIFIER DAMAGE.</p>
--

OPERATING CONTROL AND FEATURES

Top Panel Features

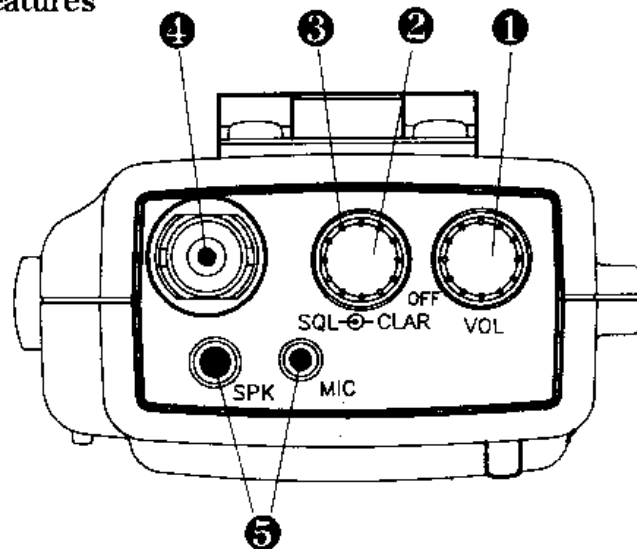

1. **Off/On, Volume** : Turn this button clockwise to turn power on and set desired listening volume.

2. **Squelch** : This control is used to cut off or eliminate receiver back ground noise in the absence of an incoming signal. For maximum receiver sensitivity, it is desired that the control be adjusted only to the point where the receiver background of ambient back ground noise is eliminated. The incoming signals that are then received will be stronger than the background noise.

3. **Clarifier** : Allows variation of the received frequencies above and below the channel frequency. Although this control is intended primarily to tune in SSB signals, it may also be used to optimize AM signals.

4. **Antenna Connector** : This radio uses a BNC type connector for use with the supplied custom flexible antenna. This antenna provides good performance given its overall size. However, longer antennas will substantially increase the users distance with the radio.

5. **Microphone and Speaker Jack** : 2.5mm and 3.5mm jack for connection of optional speaker microphone accessory.

Dual Cover : When speaker/microphone are not being used, this prevents dirt and water from getting inside the CB.

OPERATING CONTROL AND FEATURES

Side and Back Panel Features

1. Function Button (Func) : This button allows for activation of the secondary feature in each of the front panel of the radio. The features that are activated by the FUNC button are those that are in the blue letters. These features are the following: SHIFT, RPT, MIC-G and LOCK. In addition, the "Hi/Low" power function is controlled by the "FUNC" button.

2. Frequency Up/Down Buttons : When pressed, these buttons are used to select any one of the amateur band desired. Press the "UP" arrow to move to a higher frequency than is currently shown on the display. Press the "DWN" arrow to move to a lower frequency than is currently shown on the display. In either the "UP" or "DWN" mode, when you press and hold the frequency button for longer than one half of a second, the frequency will continuously move to the next until you release the button.

3. Push-To-Talk (PTT) switch : The receiver and transmitter are controlled by the push-to-talk switch. Press the switch and the transmitter is activated: you can now send a message. To receive, release the push-to-talk switch. When transmitting, hold the unit two inches from your mouth and speaker grill area.

4. Battery Pack Latch : Sliding this button up in it's tracks allows the battery case to be removed once it is placed on the radio.

5. Belt Clip : Allows for ease of carrying while attached to users belt.

6. Flexible Wrist Strap : Place strap around the wrist to prevent unit from falling to the ground in the event it falls out of users hand.

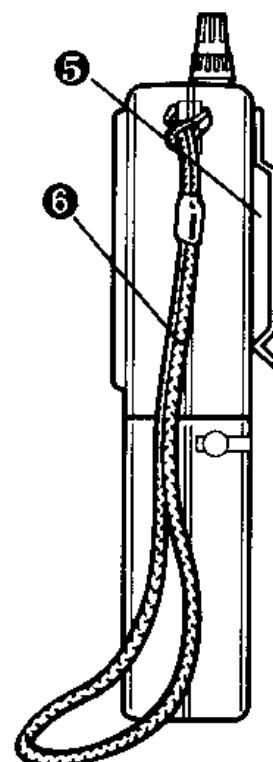
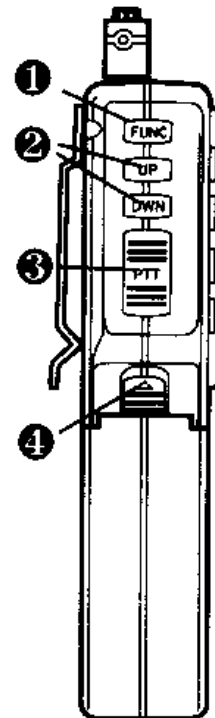

DESCRIPTION OF FEATURES (CONT)

Front Panel Features

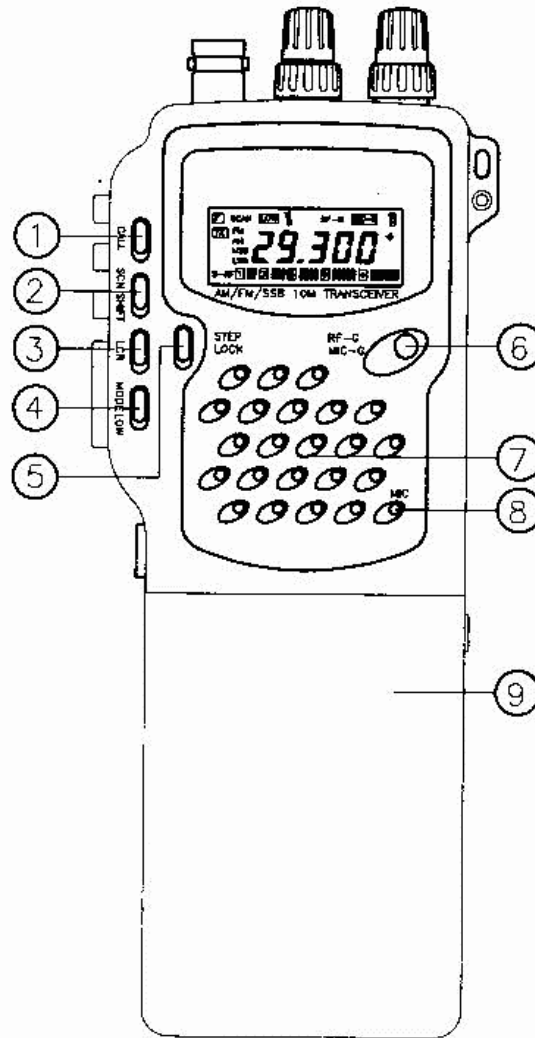

1. Call : For Call monitoring on call frequency 29.300MHz, just press "CALL". 29.300 flashes appears on the display, and the transceiver stays on all frequency 29.300MHz. To release Call monitoring, press "CALL". The previously selected frequency appears on the display.

2. Scan : Allows the radio to automatically scan through all frequency, stopping at any frequency that is busy with signals being communicated. It will remain on that frequency during the conversation, and will not reactivate scanning until roughly 5 seconds after the communication signal has ended. To activate, press the SCN/SHIFT button. The word SCAN will appear on the display. To stop, press the SCN/SHIFT button again.

Shift : This button is used to shift the TX frequency from 0 to 990MHz than RX frequency.

To Turn-On, press the "Func" button first, followed immediately by the "SCN/SHIFT" button. The word will appears on the display and press the button again as above. The word "+" will appears on the display and press the button again as above. The word "-" will appears on the display.

To Turn-Off, press the "Func" button first, followed immediately by the "SCN/SHIFT". The word will not appears on the display. Press longer than 3 seconds "SCN/SHIFT" button to select the shift frequency from 0 to 990KHz.

3. LCR (Last Channel Recall) : This feature allows the user to activate the last channel that was used prior to the current channel. To activate, press the LCR button once. This changes the channel back to the last one that was previously used. Press again to return to the first channel displayed.

4. Mode : Allows selection between the four operational modes of the radio (AM/FM/USB/LSB). To select your desired mode, press the "Mode" button until you see the mode in which you desire. The order of appearance is AM, then FM, then USB, and then LSB.

Selectable Hi/Low Power : The unit has been designed with proprietary circuitry that gives superior transmitting performance. This gives the user the ability, depending on the usage application they are in, to select between two power levels. Low power output mode will give the user significantly longer battery life estimated to be twice as long as when in the full power mode.

It is recommended that when you only need a range of 1/2 mile or less, the "low" position would provide more than adequate output power. If you need distances greater than that, leave the radio in the "Full" power mode.

To Change the Power Output Level :

- A) Press and release the "Func" button.
- B) Then press and release the "Low" button. The word "Low" will appear on the display. The power out level is now 1 watt on the AM/FM mode. This is recommended when communicating in short range, such as around 1/2 mile or less.
- C) To return to full power, simply press the "Func" button again, followed by the "Low" switch. This will return the radio to the full power position, which is 4 watts in AM/FM.

5. Step : This button is used for select one of the frequency step (1KHz, 10KHz, 100KHz).

Lock : The LOCK feature allows the user to "LOCK" virtually all of the button features on the radio so that once they are set, they can not be activated. This will prevent the radio from having its operation modes changed once the user has them set the way they like. To activate, press the "LOCK" button, followed by the "LOCK" button. The word "On" will appear on the display. With this feature activated, the only buttons that will work are the Light (longer than 1 second the "Func" button) and the PTT (Transmit) button. To deactivate, simply press the "Func" button again, followed immediately by the "LOCK" button.

6. **RF-G (RF Gain) :** Allows to optimize the incoming signal. There are two settings for this feature: OFF, which creates the maximum amount of RF-Gain, and "Activated", which can be identified by having the word "LOCAL" on the display. Activating the "RF-G" feature helps to attenuate very strong signals that are produced from another radio that is in very close proximity to the unit. To activate this feature, press the "RF-G/MIC-G" button. To turn this feature off, repeat this process.

MIC-G (MIC-Gain) : When activated, the MIC-G feature actually adjusts the microphone gain in the transmit mode. On the unit activating the MIC-Gain feature would have its best application when the user has a very strong, "booming" voice tone that would create a distorted signal going into the microphone. Because this situation will only occur in rare situations, the MIC-Gain feature in the OFF position will give the user maximum sensitivity.

To Turn-On, press the "Func" button first, followed immediately by the RF-G/MIC-G button. The letters "MIC-G" will appear on display.

To Turn-Off, press the "Func" button again, followed immediately by the RF-G/MIC-G button.

7. Speaker : High quality, impact resistant output speaker for clear output reception.

8. Electronic Microphone : Front mounted, electrostatic condenser microphone for clear high quality transmission power. You should hold the radio 2-4 inches from your mouth and speak in a normal voice.

9. Battery Case : Slide on battery case, which contain 9 "AA" batteries. (See "batteries" for installation instructions). We recommend only using AA Ni-Cads in this radio.

Special Function

BEEP Tone : Turning on power switch with keeping PTT button pressed sets beep mode On-Off.

Display Lamp : Provides lighting of entire digital liquid crystal for use in dark or night time applications. Press the longer than 2 seconds the "Func" button, and the lamp will stay on. If you want to turn it off, simply press the longer than 2 seconds the "Func" button a second time.

Tone Burst : This button is used for triggering european type repeaters. Press the "FUNC" button first, followed immediately by the "PTT" button and a 1750Hz Tone burst generator actuates and you can access the repeater.

Display Panel Features

Illustrated below are all the VISUAL INDICATORS that appear on the display, and the corresponding feature function that they associate with:

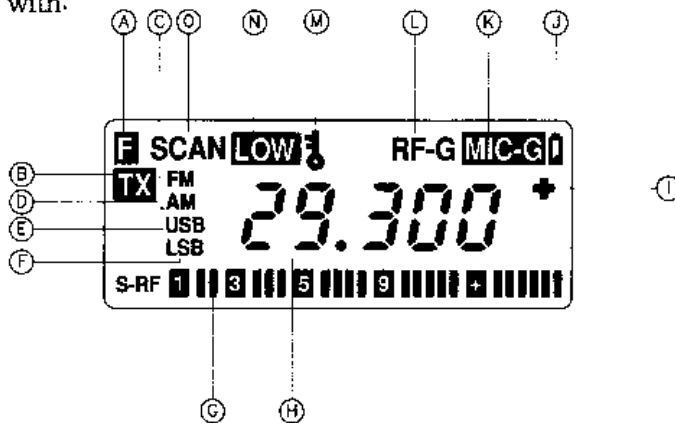

Liquid Crystal Display Panel : The state of the art liquid crystal panel provides the user with a visual information center on the operation and status of the unit.

CAUTION : Due to the components inherent in them, liquid crystal displays should not be subjected to extremes of temperature or humidity. If the unit is exposed to temperatures below -20°C (-5°F) or above $+60^{\circ}\text{C}$ ($+140^{\circ}\text{F}$), the display may temporarily cease to function properly, and in some cases, could result in permanent damage. Do not subject radio to extreme conditions, such as a closed automobile in direct sunlight or continuous sub-zero temperatures.

All liquid crystal displays have a preferred viewing angle when the display contrast is at a maximum. The best viewing point will vary by user, depending on such variables as temperature, humidity, battery condition, and the actual users eyesight.

A. Function Mode : Indicated the "Func" button has been selected, which allows for operation of many of the "transmit" mode.

B. TX : Indicates that radio is in the "transmit" mode.

C. FM : Indicates FM mode operation.

D. AM : Indicates AM mode operation.

E. USB : Indicates upper side band mode operation.

F. LSB : Indicates lower side band mode operation.

G. Signal/RF Output Meter : Your unit incorporates a eighteen segment incoming signal and power output meter in the liquid crystal display panel.

When receiving a signal, the meter will indicate how strong the signal is. A weak signal will be indicated by five or seven segments, while a very strong signal will have 9 or more segments.

When transmitting, the letter "TX" will appear on the display. If the radio is operating in the HIGH power position, 9 to 10 segments will be displayed, depending on the condition of your batteries. If the radio is operating in the LOW power position, only 3 to 5 segments will appear.

H. Frequency Indicator : Displays either the corresponding frequency, in which the radio is operating on.

I. "+" : Indicates + and - shift mode.

J. BATT : Indicates batteries are getting low.

K. MIC-G : Indicates that the Mic-Gain feature has been activated.

L. RF-G : Indicates that RF-Gain feature has been activated.

M. OL : Indicates the key lock feature has been activated.

N. Low : Indicates that user has selected the Low power output mode. When the indicator is not shown, radio is in full output mode.

O. Scan : Indicates that the radio is in the Scan mode, which works in conjunction with all amateur band.

BATTER PACK INSTRUCTIONS

For maximum power output and performance from the unit, we strongly recommend that you only use "AA" Ni-Cad batteries in your battery pack. Due to the voltage rating and power consumption of the radio, Ni-Cad,s deliver superior performance and life than alkalines. These batteries are readily available from your radio dealer or other electronic stores. While the radio will work with alkaline batteries, you will definitely not achieve full transmit power or length of talk time on each set of batteries when compared to Ni-Cad's. The battery pack supplied with the radio is a slide on battery case that requires 9 "AA" size batteries (preferably Ni-Cads) To install the 9 batteries into the case, hold the pack in one hand, while at the same time using your other hand to press down on the center tab (see illustration). The pack will open into two distinct pieces, with polarity markings for batteries to install on each side. Please pay attention to the polarity markings, as incorrect battery installation can damage the radio.

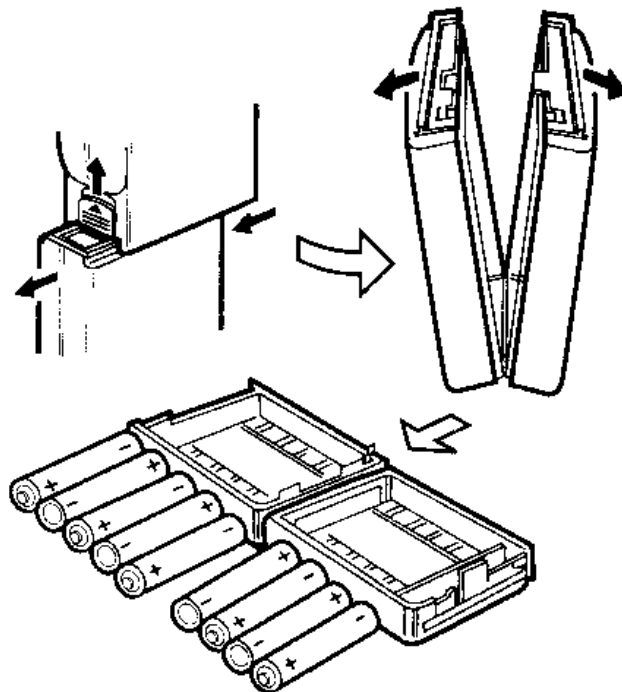

IMPORTANT When the batteries voltage become low, in addition to the "Battery Low" indicator coming on the display, you will experience a BLANK DISPLAY when you press the PTT button. This is due to the needed voltage being greater than the power you have left in the battery pack. This "Blank Display" situation is a normal reaction to the batteries becoming low. Please replace or re-charge to batteries immediately when this situation occur.

BATTERY PACK INSTRUCTIONS (CON'T)

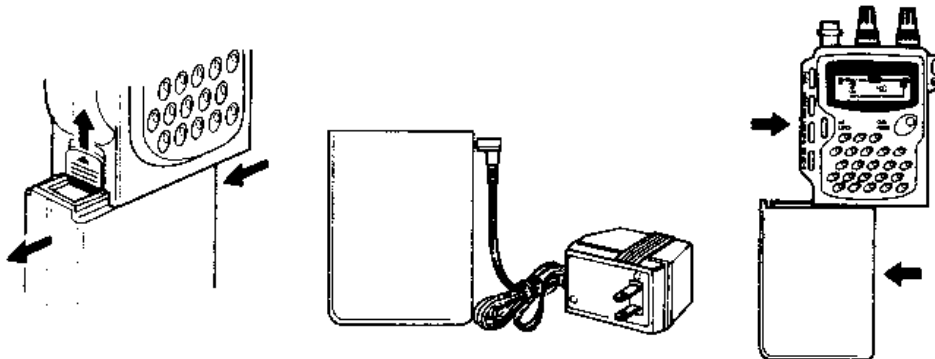

To charge the "AA" Ni-Cad batteries using the plug in Wall Charger:

1. Slide the battery pack off the bottom of the radio.
2. Plug in the charger cord into the side of the battery pack. The "Charge" light will stay on during charging. We recommend that when you charge batteries for the first time, they should be charged 12-14 hours. After that, 8-10 hours will be sufficient.
3. Re-attach your pack to the radio, and you are ready to use.

Important tips When Using and Recharging Ni-Cad Battery Pack's.

- * Never try recharging alkaline batteries. Permanent damage to the batteries and/or radio could result, which is not covered by our warranty.
- * Make sure you use a proper recharging power supply or drop in charger. The BP-732 "Drop-In Charge" is excellent choice for this use. ask your dealer about this product.
- * It is OK to recharge the battery pack while it is attached to the radio. However, make sure that you have the power turned off during charging.
- * To maximize your Ni-Cad battery life, let them totally discharge until the "Batt Low" symbol appears on the display. Then, by recharging the batteries to their maximum, their useful life will be extended.
- * **IMPORTANT** When the batteries voltage become low, in addition to the "Batter Low" indicator coming on the display, you will experience a BLANK DISPLAY when you press the PTT button. This is due to the needed voltage being greater than the power you have left in the batteries pack. This "Blank Display" situation is a normal reaction to the batteries becoming low. Please replace or re-charge to batteries immediately when this situation occurs.

OPERATING PROCEDURE

Radio Setup

1. Attach the antenna to its connector on the top of the unit.
2. Slide in the battery pack (see battery pack instructions)
3. Turn the power On/Off-Volume setting.
4. Press the "Mode" selection button continuously until you find the mode of operation you desire to operate (AM, FM, USB, LSB)
5. Adjust the SQUELCH control to desired level.

OPERATING PROCEDURE TO TRANSMIT

1. Select the desired frequency of transmission.
2. Press and hold the press-to-talk switch. The receiver and transmitter are controlled by the press-to-talk switch. Press the switch and the transmitter is activated. Release the switch to receive.
3. Hold the microphone two inches from your mouth, and speak in a clear normal voice.
4. The S-RF meter will indicate relative power output.

OPERATION PROCEDURE TO RECEIVE

1. Adjust the VOLUME control until you reach your desired listening level.
2. Select the desired operating frequency.
3. Listen to the background noise coming from the radio. Turn the squelch control slowly until the noise just disappears. (No signal should now be present). Leave the control at this setting. The SQUELCH is now properly adjusted. The receiver will remain quiet until a signal is actually received. Do not advance the knob too far, as some of the weaker signals will not be heard.
4. Adjust the "CLARIFIER" control to clarify the SSB signals.

RECEIVING SSB SIGNALS

There are four types of signals presently used for communications in the Amateur Band: AM, FM, USB and LSB. When the MODE switch on your unit is placed in the AM position, only standard double-sideband, full carrier signals will be detected. An SSB signal may be recognized while in the AM mode by its characteristic "Donald Duck" sound and the inability of the AM detector to produce an intelligible output. The USB and LSB modes will detect upper sideband and lower sideband respectively, and stand AM signals.

SSB reception differs from standard AM reception in that SSB receiver does not require a carrier or opposite sideband to produce an intelligible signal. A single-sideband transmitted signal consists only of the upper or the lower side band and no carrier is transmitted. The elimination of the carrier from the AM signal helps to eliminate the biggest cause of whistles and tones heard on frequency which make even moderately strong AM signals unreadable. Also, SSB takes only half of an AM mode, therefore two SSB conversations will fit into each frequency. The reduction in frequency space required also helps in the receiver because only half of the noise and interference can be received with 100% of the SSB signal.

An SSB signal may be received only when the listening receiver is functioning in the same mode. In other words, an upper sideband signal (USB) may be made intelligible only if the receiver is functioning in the USB position.

If a lower side band (LSB) signal is heard when the receiver is in the USB mode, no amount of tuning will make the signal intelligible. The reason for this may be understood if you consider that when the modulation is applied to the transmitter's microphone in the USB mode, the transmitter's output frequency is increased. Whereas in the LSB mode the transmitter's output frequency output frequency is decreased. The result in listening to the receiver is that when the MODE switch is in the proper position (either USB or LSB), a true reproduction of single tone of modulation will result, and if the tone is increased in frequency (such as a low-pitched) whistle or a high-pitched whistle) you will hear the increase in the output tone of the receiver. If the incorrect mode is selected, an increase in tone of a whistle applied to the transmitter will cause a decrease in the resultant tone from the receiver.

RECEIVING SSB SIGNALS (CON'T)

Thus when a voice is used in place of a whistle or tone, in the proper listening mode the voice will be received correctly whereas in the incorrect mode, the voice will be translated backwards and cannot be made intelligible by the clarifier control. When listening to an AM transmission, a correct sideband is heard in either mode since both upper and lower sideband are received.

Once the desired SSB mode has been selected, frequency adjustment may be necessary in order to make the incoming signal intelligible. The CLARIFIER control allows the operator to vary the frequency above and below the exact-center frequency of the received signal. If the sound of the incoming signal is too high or too low pitched, adjust the Clarifier control. Consider it as performing the same function as a Dictaphone speed control. When the speed is set too high, voices will be high-pitched, and if set too low, voices will be low-pitched. Also, there is only one correct speed that will make a particular tape produce the same sound that was recorded. If the tape is played on a player that rotates in the wrong direction (opposite sideband), no amount of speed control (Clarifier) will produce an intelligible sound.

An AM signal received while listening in one of the SSB modes will produce a steady tone (carrier) in addition to the intelligence, unless the SSB receiver is tuned to exactly the same frequency by the Clarifier control. For simplicity it is recommended the AM modes be used to listen to AM signals.