



WALKIE TALKIE





danita mikrofon

danita microphone
 danita mikrofon. Lev. med 4 eller 5 polet stik
 Mål (BxHxD): 55x86x40 mm
 4 pol. No. 0452
 5 pol. No. 0454



danita 1 mikrofon

danita 1 microphone
 danita mikrofon. Leveres med 4 eller 5 polet stik
 Mål (BxHxD): 55x100x40 mm.
 4 pol. No. 0458, 5 pol. No. 0456

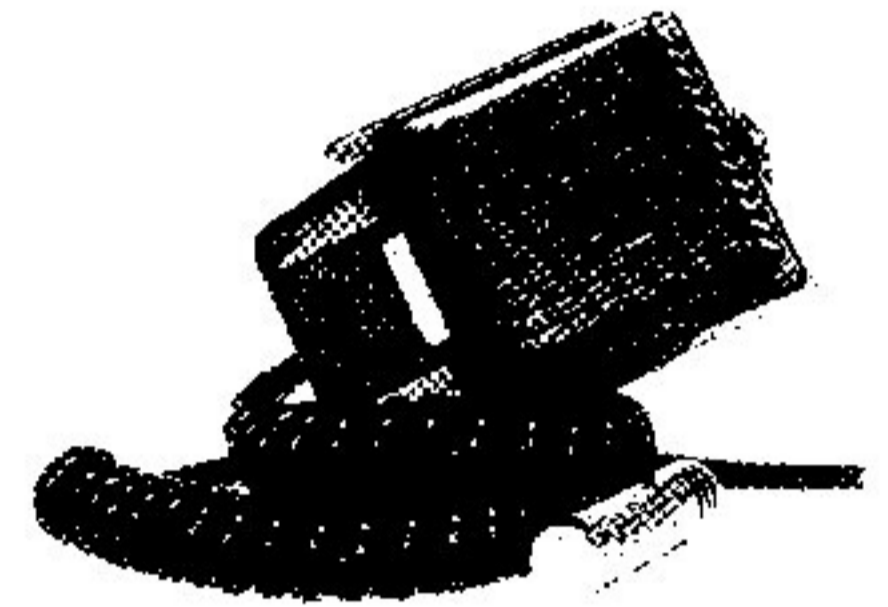

danita 408 mikrofon

danita 408 amplifier microphone
 danita 408 forstærkermikrofon
 Variabel forstærkning 0-44 dB
 Benyt et stk. 1,5 V batteri LR6
 Leveres uden stik og batteri
 Mål (BxHxD): 60x93x38 mm
 No. 0453

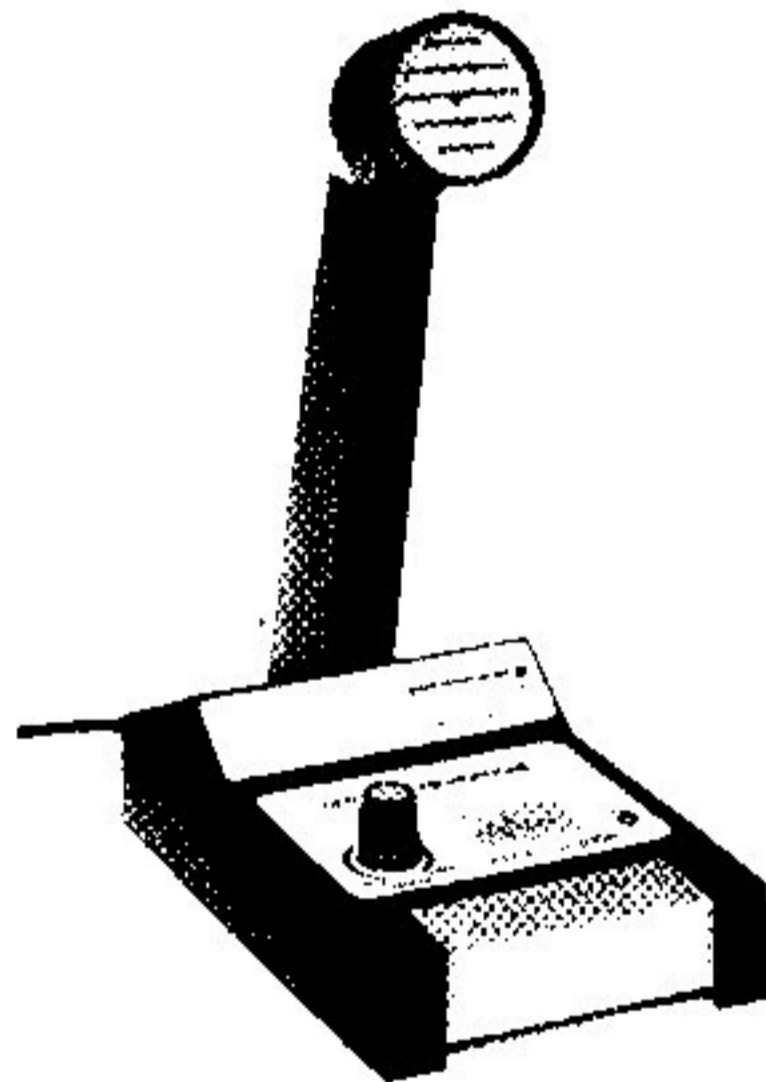

Bordmikrofon KM-8800

Base amplifier microphone w/compressor
 Forstærkermikrofon med variabel forstærkning
 0-25 dB
 Kompressor-forstærker
 Frekvens : 200-5000 Hz
 Impedans 2 kΩ
 Benyt et stk. 9 V batteri 6LF22
 Leveres uden stik og batteri
 No. 331548

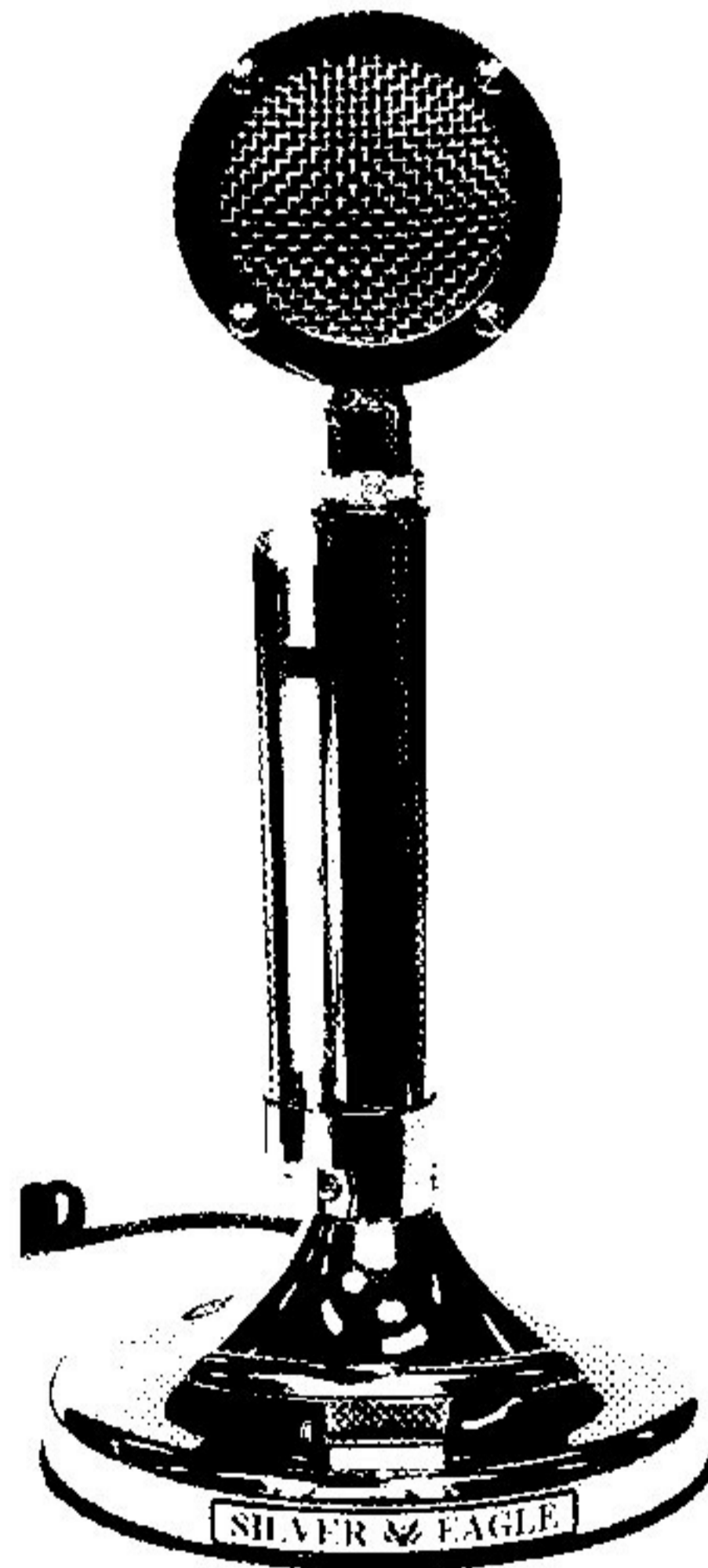

Bordmikrofon Astatic Silver-Eagle

Base silver amplifier microphone
 Forstærkermikrofon med variabel forstærkning
 0-26 dB
 Frekvens : 200-20.000 Hz
 Impedans 5 kΩ
 Mikrofon type: Krystal
 Benyt et stk. 9 V batteri 6LF22
 Leveres uden stik og batteri
 No. 331577

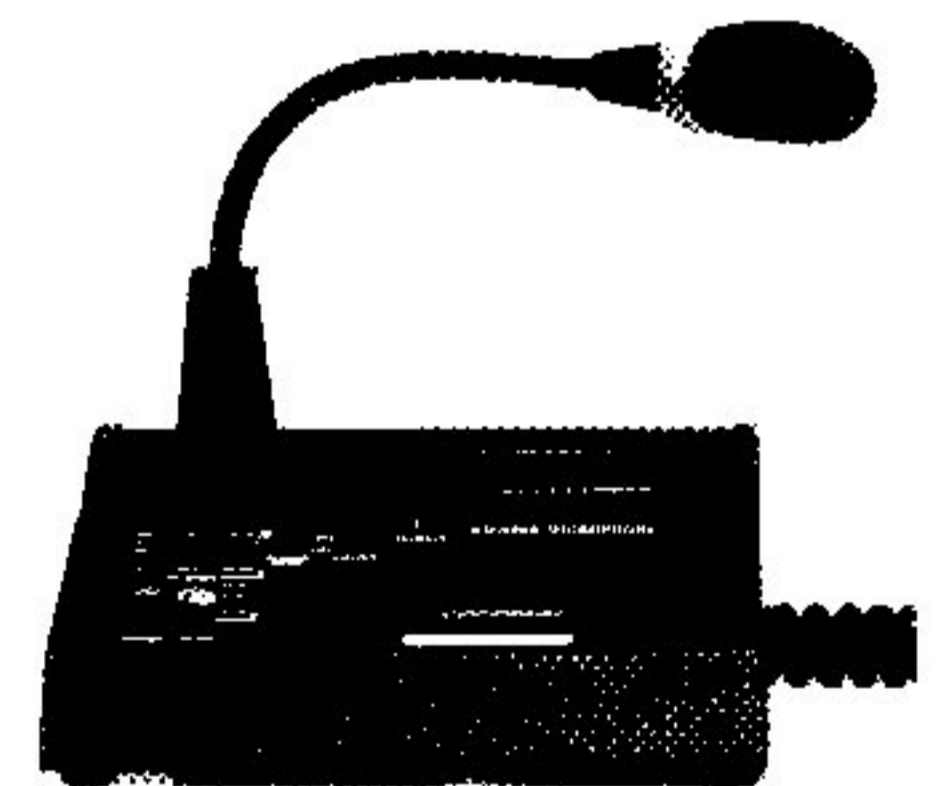

Bordmikrofon KM-9900

Base amplifier microphone w/echo and Roger-Beep
 Forstærkermikrofon med variabel forstærkning
 0-44 dB. Ekko variabel mellem 10-100 mS
 Roger-Beep ON/OFF. VU-meter.
 Frekvens: 150-10.000 Hz
 Impedans 2 kΩ. Benyt et stk. 9 V batteri 6LF22.
 Leveres uden stik og batteri
 No. 331553



Højtaler KLS-300

8 Ω speaker. Max 8 Watt
8 Ω højtaler. Max 8 watt. Konstant 4 watt
Leveres med bøjle og ledning med JP3 stik
Mål (BxHxD): 80x65x55 mm
No. 332132



Højtaler KLS-120

8 Ω speaker w/noise filter. Max 8 Watt
8 Ω højtaler. Max 8 watt konstant 6 watt
Støjfilter og 8 dB dæmpnings mulighed
Leveres med bøjle og ledning med JP3 stik
Mål (BxHxD): 112x96x38 mm.
No. 332102



danita mini højtaler

8 Ω mini speaker. Max 5 Watt
8 Ω mini højtaler. Max 5 watt
Leveres med bøjle og ledning med JP3 stik
Mål (BxHxD): 73x65x35 mm
No. 0571



Letvægts højtaler- og mikrofon sæt EP-300

Light weight ear and microphone set
Letvægts hovedtelefonsæt med tast. Højtaler 10 Ω .
Stik tilpasset danita 608
No. 331567

danita hornhøjtaler HH1

Horn speaker. 8 Ω . Max 5 Watt
Hornhøjtaler 8 Ω . Max 5 watt
Leveres med ledning og JP3 stik
Mål (ØxD): 133x130 mm.
No. 0140



Højtaler/mikrofon SJS-111

Speaker/microphone
Højtaler/mikrofon
Højtaler 8 Ω
Stik tilpasset danita 608
Måler kun: (BxHxD) 48x85x25 mm
No. 331594



Højtaler/mikrofon SJS-117

Speaker/microphone
Højtaler mikrofon
Højtaler 8 Ω .
Stik tilpasset danita 608
Måler kun: (BxHxD) 42x65x20 mm.
No. 331563

Hovedtelefonsæt SJS-112Y

Headset
Hovedtelefonsæt. Højtaler 32 Ω
Stik tilpasset danita 608
No. 331569



Strømforsyning KNT-250

Power supply 220VAC-13VDC 2,5 Amp. Temporary 3,5 Amp.
220 volt til 13 volt stabiliseret strømforsyning
2,5 amp. kontinuerligt og 3,5 amp. kortvarigt
Mål (BxHxD) : 108x79x160 mm.
Vægt : 1,4 kg
No. 331459

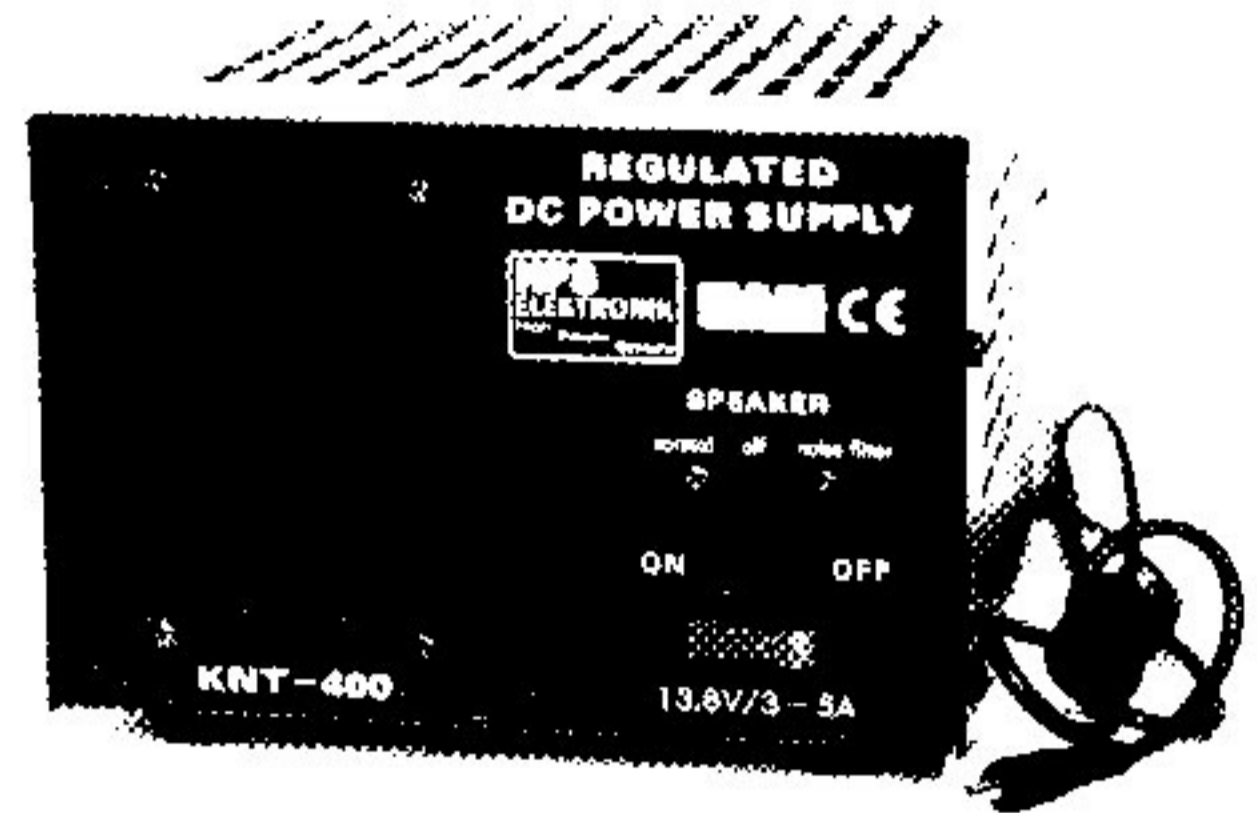

Strømforsyning m/højtaler KNT-400

Power supply 220VAC-13VDC 3 Amp. Temporary 5 Amp.
8 Ω build in speaker w/ noise filter.
220 volt til 13 volt stabiliseret strømforsyning
3 amp. kontinuerligt og 5 amp. kortvarigt
8 Ω indbygget højtaler med støjfilter
Mål (BxHxD) : 144x112x209 mm.
Vægt : 3 kg
No. 331457

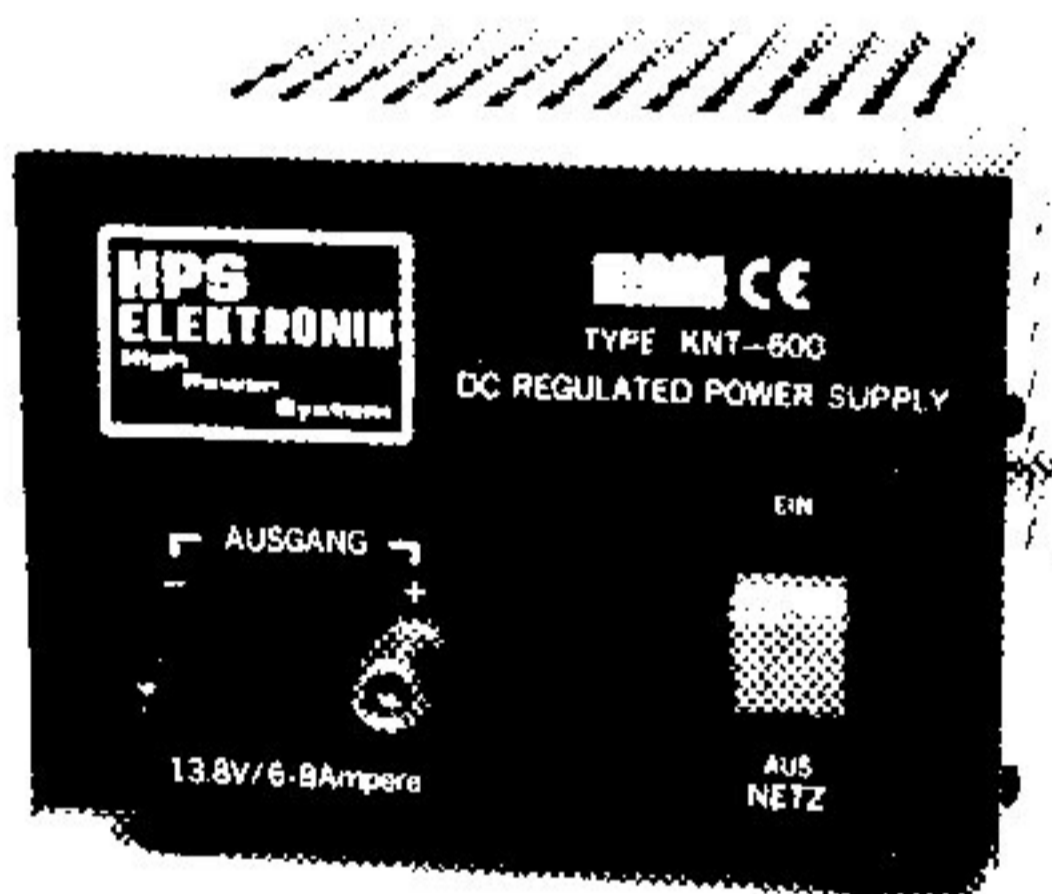

Strømforsyning KNT-600

Power supply 220VAC-13VDC 6 Amp. Temporary 8 Amp.
220 volt til 13 volt stabiliseret strømforsyning
6 amp. kontinuerligt og 8 amp. kortvarigt
Mål (BxHxD) : 140x100x235 mm
Vægt : 4 kg
No. 331403

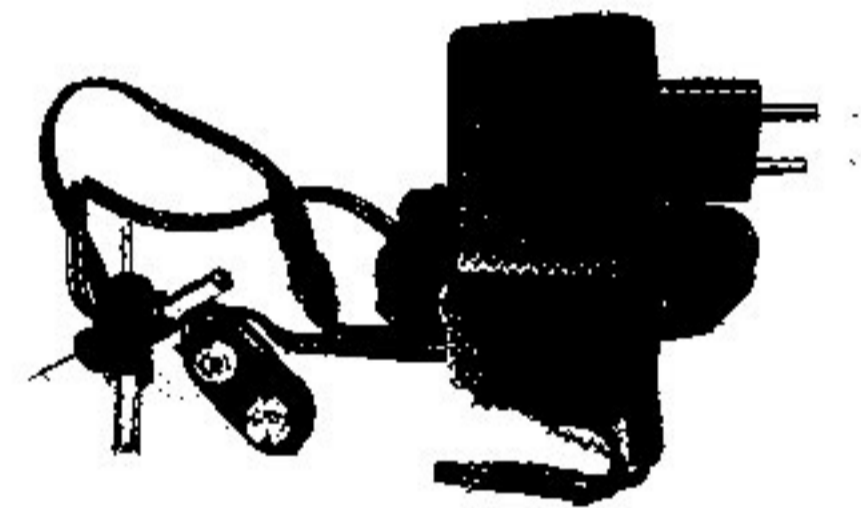

Lader FW3019

220 VAC to 5-14 VDC 50 mA NiCd wall charger
Væglader 220 volt. 50 mA ladestrøm
For opladning af NiCd celler (5-10 stk)
No. 0040

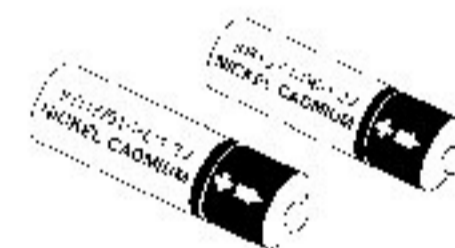

Genopladelige celler

1,2V NiCd or NiMH batteries
1,2V 1.300 mA NiMH celle No. 0032
1,2V 700 mA NiCd celle No. 0031

Spændingsdeler K 2412

DC-DC converter 24 - 13V 8 Amp. Temporary 10 Amp.
Spændingsdeler 24-13 volt
8 amp. kontinuerligt og 10 amp. kortvarigt
Stabiliseret og overbelastningssikret
Mål (BxHxD) : 122x40x175 mm
Vægt: 475 g
No. 332401

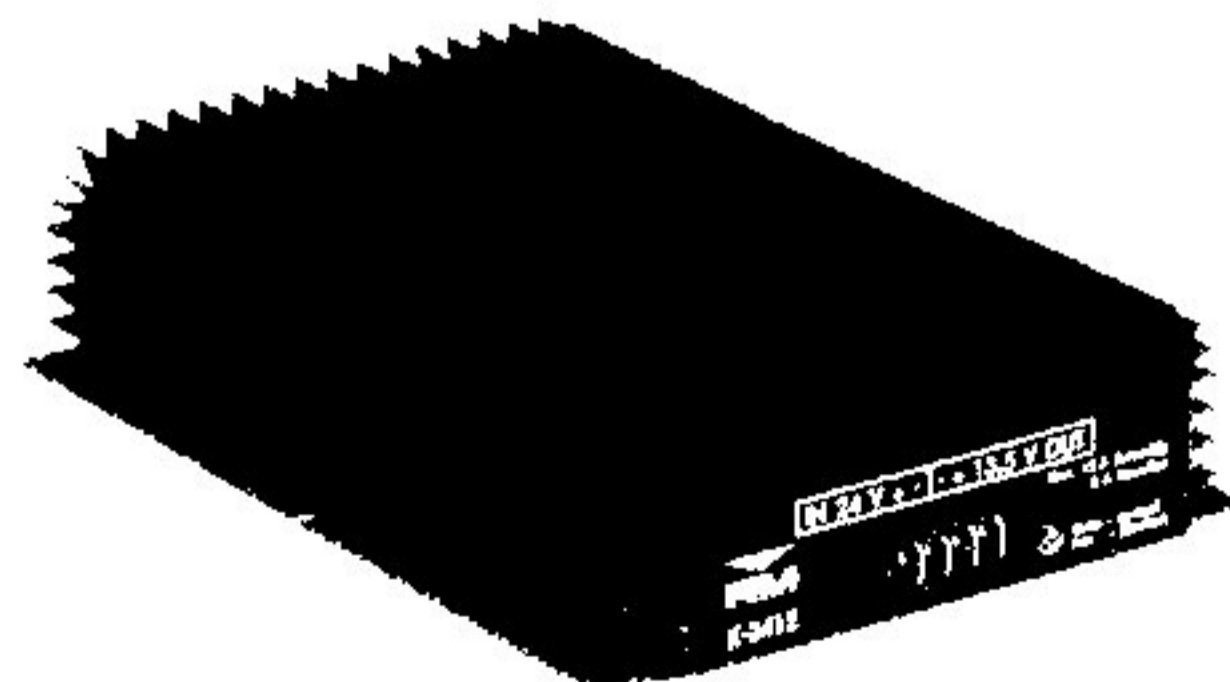



Antenne forstærker K-27 M

RX amplifier

Modtager forstærker

Forstærkning regulerbar fra -10 / +25 dB. Tilsluttes 12 V strømforsyning 0,1 ampere. Max. sendereffekt 50 watt
No. 331736

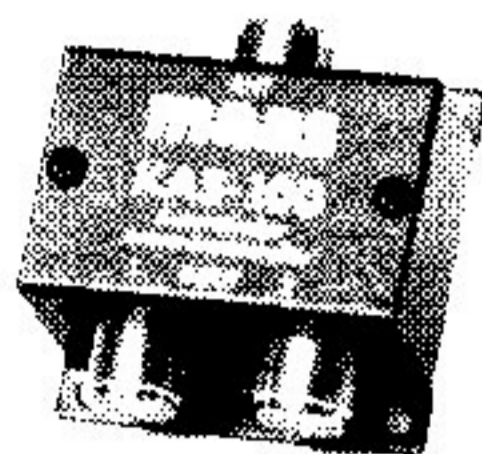

Antenneomskifter, elektronisk KAS-100

Electronic antenna switch

Antenneomskifter. Skifter selv ved sending.

Frekvens 26-30 MHz
Max. sender effekt 100 watt
No. 331952



Antenneomskifter KAS-3

Antenna switch. 1 to 3

Antenneomskifter 1 til 3

Frekvens 26-29 MHz

Max. sender effekt 200 watt.
No. 331901

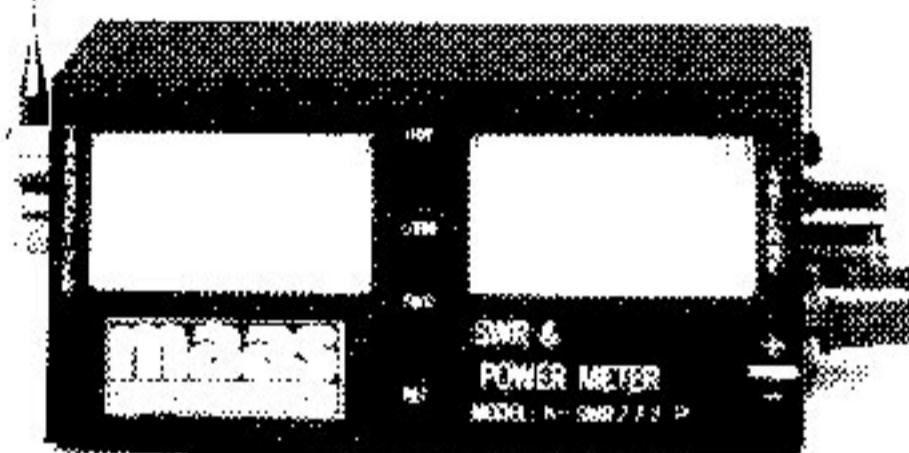

SWR meter K-SWR-222 P

SWR meter - two instruments

Standbølgeomåler for antennejustering

Frekvensområde 1,7 - 150 MHz

Måler både SWR og sendereffekt

Max. 100 watt

Mål (BxHxD): 140x60x60 mm

No. 331315



SWR meter 420A

SWR meter - one instrument.

Standbølgeomåler for antennejustering

Frekvensområde 5 - 30 MHz

Max. 10 watt

Mål (BxHxD): 85x55x75 mm

No. 0179

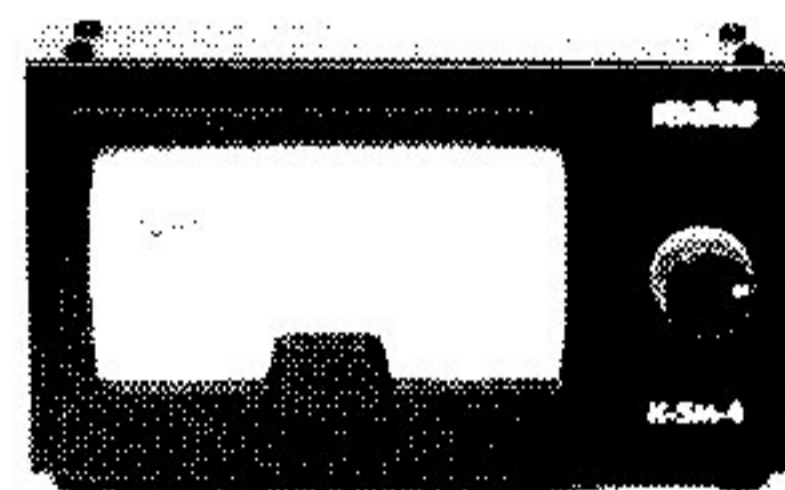

S-meter KSM-4

S-meter.

S-meter. For ekstern modtager signalvisning

Justerings mulighed

Ledning med JP2 stik

Mål (BxHxD): 160x95x70 mm

No. 331335

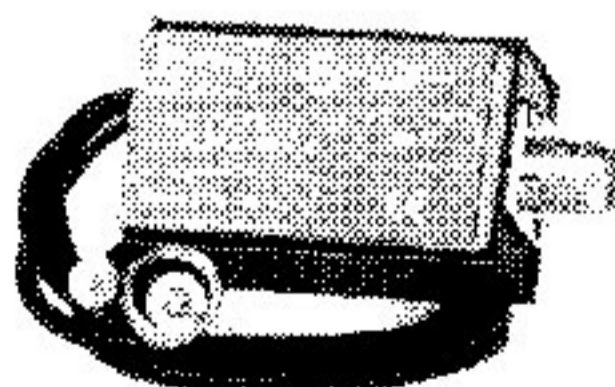

CB-Auto Radio filter KR 127

CB - radio antenna filter

CB - autoradiofilter

Fordeler bilens CB antenne til autoradio og CB

No. 331947



Strømtøjfilter NF-20

DC noise filter max 8 Amp.

DC støjfilter max. 8 amp.

Til dæmpning af elektrisk støj på

DC ledninger

No. 331955

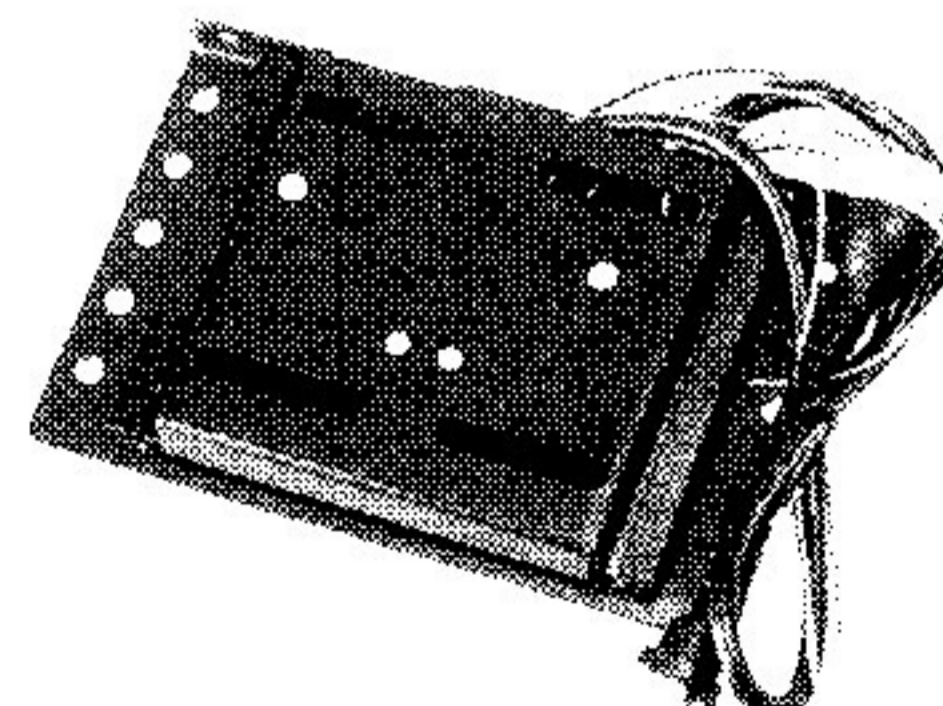

Mini kassette

Quick mini mount

Mini-kassette for hurtig tilkobling

eller flytning

Til montering af CB radio

No. 0563



T 27 F

Reduced mobile antenna
5/8 wave
5/8-bølge mobil antenne
50 Ω. Glasfiber, forkortet
m/ fjeder. Leveres med
kabel uden stik. Længde
67 cm
No. 0080 (12002)



TS 27

Reduced mobile antenna
5/8 wave
5/8-bølge mobil antenne
50 Ω
Glasfiber, forkortet
Leveres med kabel uden
stik
Længde 88 cm
No. 0207 (12003)

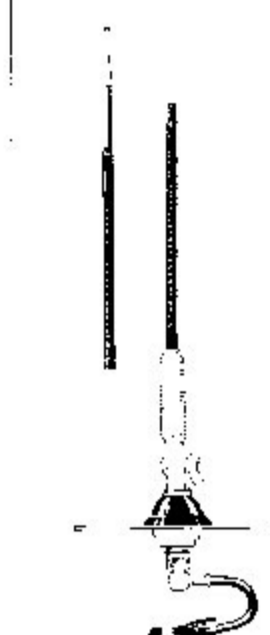

TS 27 F

Reduced mobile antenna
5/8 wave
5/8-bølge mobil antenne
50 Ω
Glasfiber, forkortet m/
fjeder. Leveres med kabel
uden stik
Længde 93 cm
No. 0206 (12004)

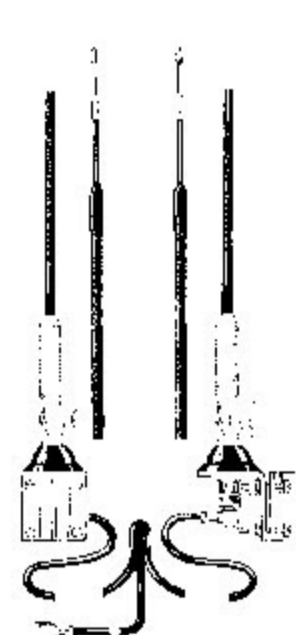

Twin TS 27 F

Co-phased mobile antenna
5/8 wave
5/8-bølge mobil
spejlanterne 50 Ω
Glasfiber, forkortet m/
fjeder. Spejlbeslag med
spec. kabel (Må ikke
forkortes). Længde 93 cm.
No. 0725 (12004)

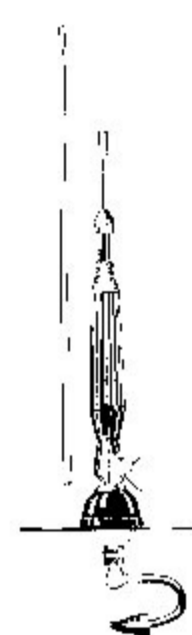

BL 27

Reduced mobile base
loaded antenna 1/4 wave
1/4 bølge mobil bundspole
antenne 50 Ω
Stål antenne, forkortet
Leveres med kabel uden
stik Længde 128 cm
No. 0201 (12007)

Super magnetantenne

Super magnet mobile antenna
Magnet mobil antenne 50 Ω. Stalantenne, leveres med kabel og
PL stik

Længde 32 cm. No. 0381

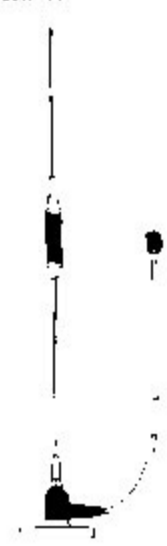

Magnet-antenne

Magnet mobile center
loaded antenna
Magnet mobil antenne 50
Ω. Stålantenne. Leveres
med kabel og PL stik
Længde 66 cm

No. 0081



Magnet-antenne 5/8

Magnet mobile 5/8 wave
antenna
5/8-bølge magnet mobil
antenne 50 Ω. Glasfiber,
forkortet. Leveres med
kabel og PL stik. Længde
67 cm.

No. 0083



Vinkel-stik

DK angle connector
Vinkelstik for DK fod
No. 071

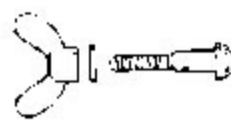

Skrue/vingemøtrik

Screw and nut
For DK, S-fod og ScanMag
No. 0710



ScanMag

ScanMag magnetic Base
Magnetfod for
mobilantenner
No. 78



Spejlbeslag

Mirror mount
For DK fod, 12,5 mm Ø.
No. 822

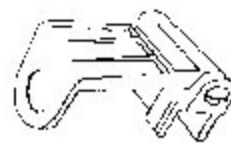

Tagrende beslag

Gutter mount
For DK fod, 17 mm Ø.
No. 0821

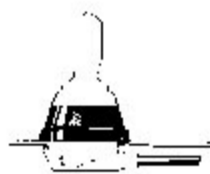

S-fod

S mount
Antennefod for mobil-
antenner. Med 4 m kabel.
Med/uden PL-stik
No. 0708/16002



DK kabel

DK cable
4 m antennekabel
med stik for DK fod.
No. 209



DK-fod

DK mount
Antennefod for mobil-
antenner. Uden kabel/stik.
21mm Ø. No. 208



GP 27 1/2

Base antenna 1/2 wave
Mastantenne 1/2 bølge
Aluminiumantenne.
Monteres på 30-45 mm
mastrør. Leveres uden
kabel. PL tilslutning
Længde 560 cm
No. 718

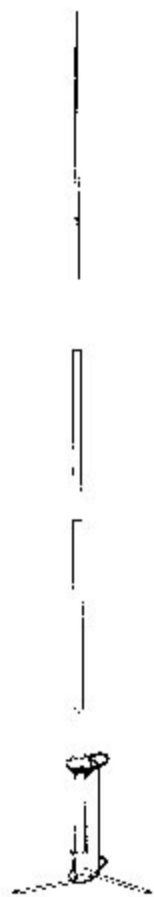

GP 27 5/8

Base antenna 5/8 wave
Mastantenne 5/8-bølge,
med radialer
Aluminiumantenne.
Monteres på 30-45 mm
mastrør. 3,5 dB gain
Leveres uden kabel. PL
tilslutning. Længde 650cm
No. 88

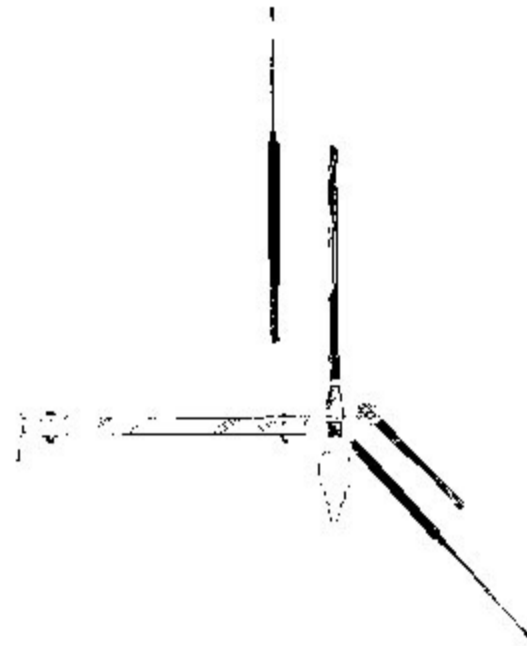

Combi 6

Balcony antenna 1/2 wave
Altan/loft antenne 1/2-bølge
Glasfiber antenne, forkortet
Med monterings beslag, uden kabel. PL tilslutning
Længde 210 cm
No. 733

TORNADO 8000

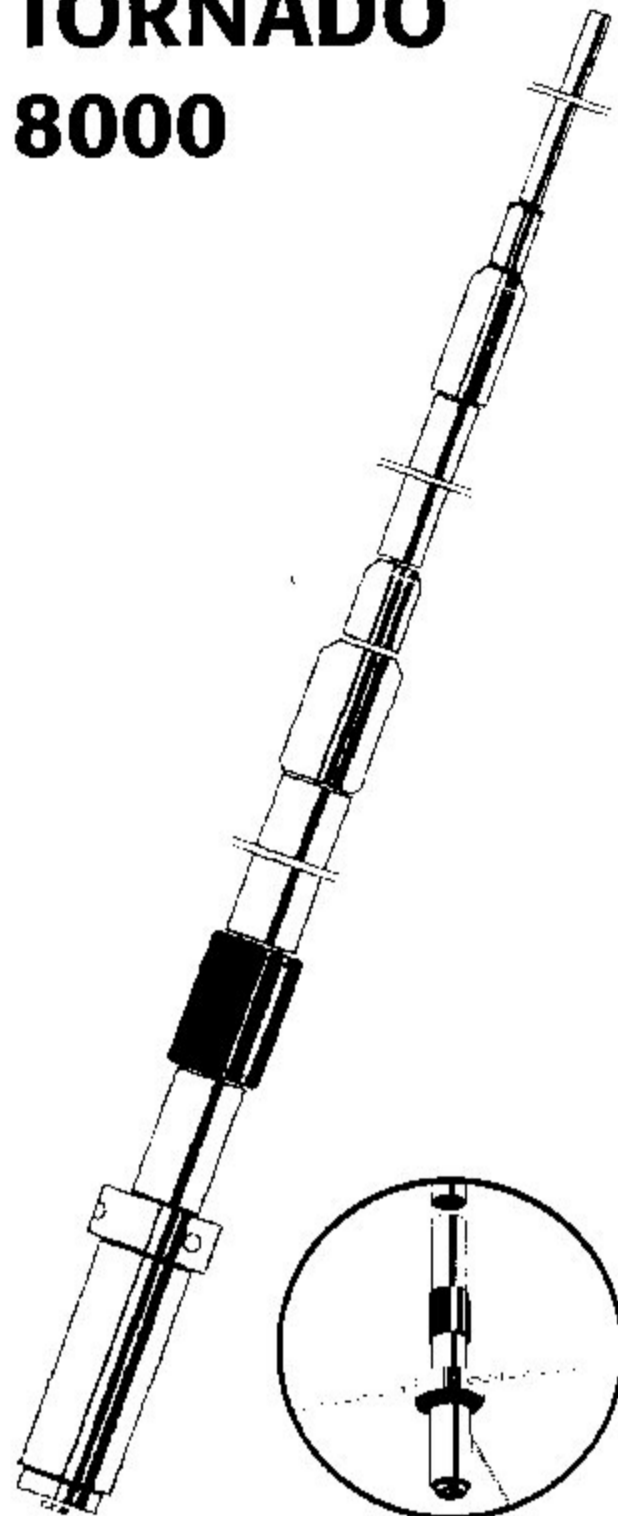

K-8000 Tornado

Base antenna 5/8 wave
Mastantenne 5/8-bølge, med radialer
Glasfiberantenne. Monteres på 30-52 mm mastrør
6,5 dB gain. Max. 1500 watt
Leveres uden kabel. PL tilslutning
Længde 620 cm. Radialer 3 stk à 200 cm
No. 330204

HURRICAN K55

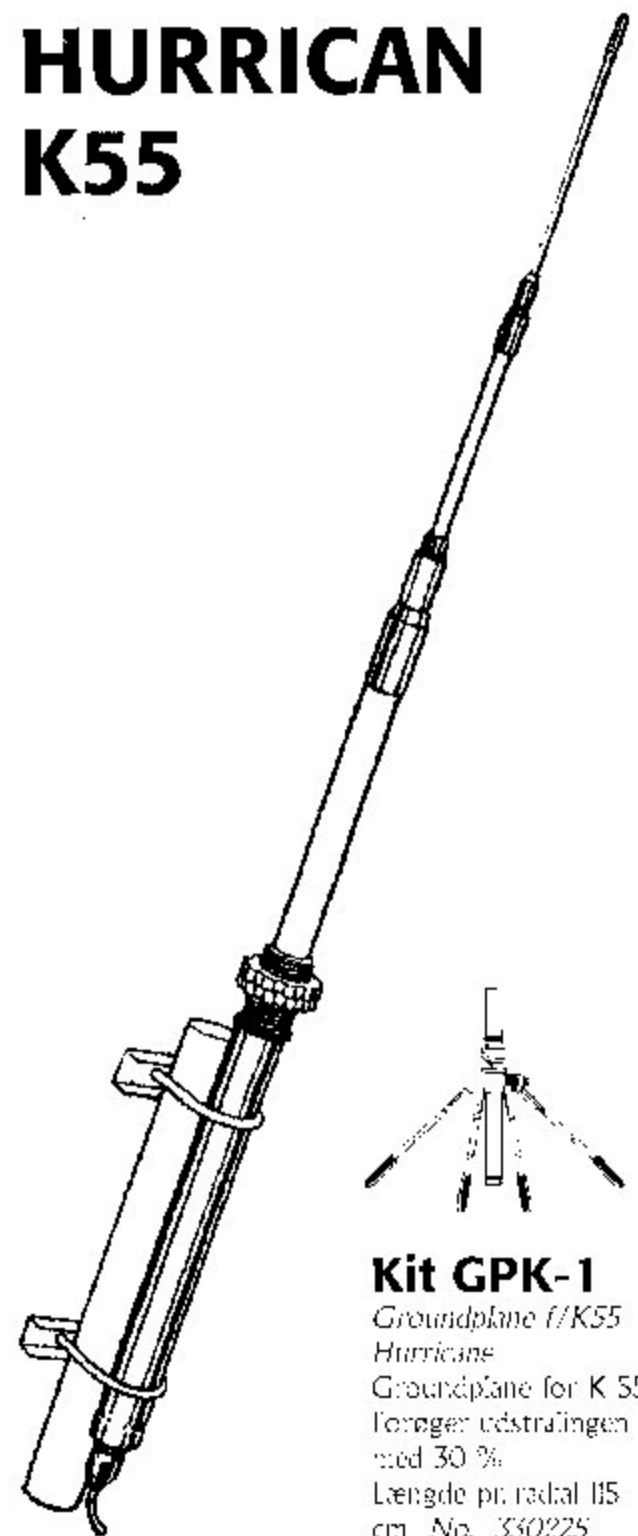

Kit GPK-1

Groundplane for K55
Hurricane
Groundplane for K 55
Forøger udstrålingen
med 30 %
Længde pr. radial 115
cm No. 330225

K-55 Hurrican

Base antenna 1/2 wave
Mast antenne 1/2-bølge
Glasfiberantenne. Monteres på 30-45 mm mastrør
9,9 dB gain. Max. 1000 watt
Leveres uden kabel. PL tilslutning
Længde 550 cm
No. 330223

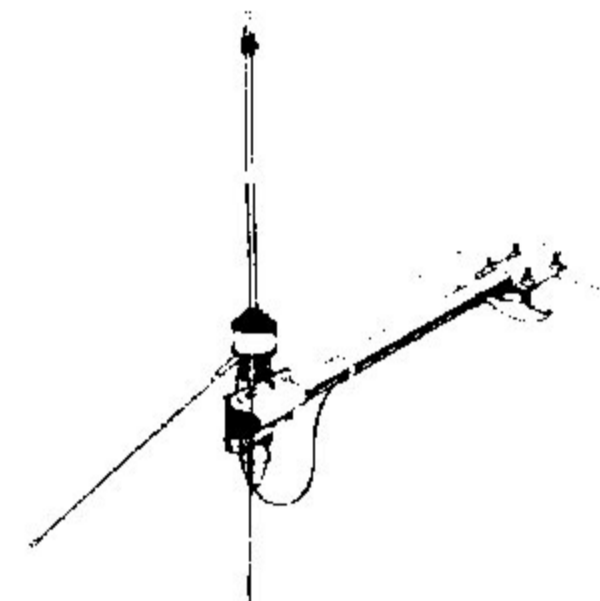

K-29 Tarax

Base / balcony antenna 1/4 wave
Mast/altan antenne 1/4-bølge, forkortet
Glasfiberpisk og radialer. Bundstykke aluminium
Max. 400 watt. Med monteringsbeslag til 30-38 mm
mastrør.
Leveres uden kabel. PL tilslutning. Længde 280 cm
No. 330270

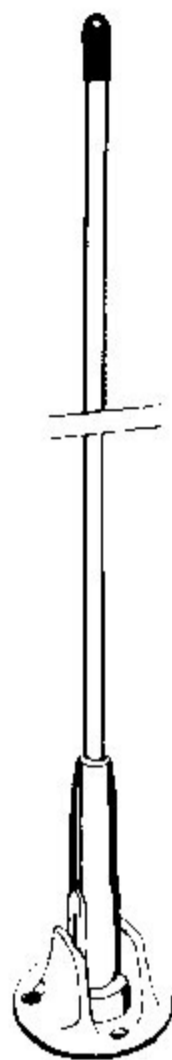

KM-5 CB

Marine antenna 1/2 wave
Glasfiber marineantenne
1/2 bølge, forkortet.
Kan lægges ned.
Max. 50 watt.
Leveres med
4 m kabel og PL stik.
Længde 150 cm
No. 330536



TS 27 5/8

Marine antenna 5/8 wave
Glasfiber marineantenne
5/8-bølge, forkortet
Til montering på
metalmast. Leveres uden
kabel. PL tilslutning.
Længde 83 cm
No. 95
(12003H hvid/white)

CONNECTORS



PL259A

Coaxial connector for 5 mm cable
PL-stik for 5 mm kabel. (RG58)
No. 0601

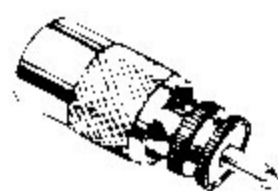

PL259

Coaxial connector for 10mm cable
PL-stik for 10 mm kabel. (RG8/213)
No. 0049

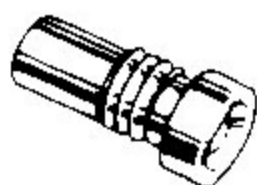

UG175

Reducer for PL259 for RG58
Reduktionsadaptør for PL259 til RG58.
No. 0048



PL259 Crimp

Coaxial crimp connector for 5 mm cable. PL-crimpstik for 5 mm kabel. (RG58)
No. 332196



GLC 97

Double male PL-dobbelt hanstik
No. 0051

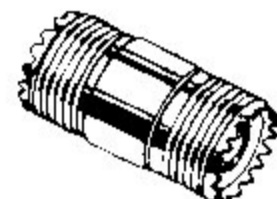

PL258

Double female PL-dobbelt hunstik
No. 0052



M359

Angle connector PL-vinkelstik
No. 0054

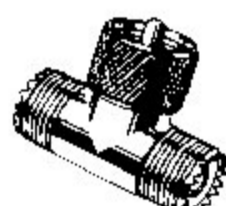

M358

T connector PL-T stik
No. 0053

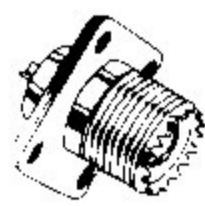

SO239

PL chassis connector PL-chassisbøsning
No. 0216

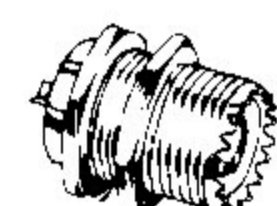

GLC94

PL chassis connector PL-chassisbøsning et-hulsmontering
No. 0057



BNC-RG58

Coaxial connector for 5 mm cable BNC stik for 5 mm kabel (RG58)
No. 0130



BNC crimp-RG58

Coaxial crimp connector for 5 mm cable BNC crimp stik for 5 mm kabel. (RG58)
No. 0130C



TNC-RG58

Coaxial connector for 5 mm cable TNC stik for 5 mm kabel (RG58)
No. 336589



TNC-PL

TNC-PL adaptor TNC-PL omformerstik
No. 0055



PL-BNC

PL-BNC adaptor PL-BNC omformerstik
No. 332257



BNC-PL

BNC-PL adaptor BNC-PL omformerstik
No. 332256



Mikrofonholder

Regular microphone holder Almindelig holder
No. 0139



Mag. mikrofonholder

Magnetic microphone holder Magnetisk holder
No. 0129



JP2

2,5 mm mini jack 2,5 mm mini jack
JP2 No. 0602



JP3

3,5 mm mini jack 3,5 mm mini jack
JP3 No. 0215



DC 1,3

DC power jack 1,3 mm DC stik 1,3 mm
No. 0641



DS-5

5 pin microphone connector 5 polet mikrofonstik
No. 0606



NC-518

6 pin microphone connector 6 polet mikrofonstik.
No. 332240



MK 4

4 pin microphone connector 4 polet mikrofonstik
No. 0213



RG58 kabel

RG58 antenna cable 5 mm 50 Ω
RG58 antenne kabel 5 mm 50 Ω
No. 0072



PL 0,5 kabel

0,5 m antenna extension cable 5 mm 50 Ω. 0,5 meter RG58 antenne forlænger kabel med PL259
No. 0045



PL 3,5 kabel

3,5 m antenna extension cable 5 mm 50 Ω. 3,5 meter RG58 antenne forlænger kabel med PL259
No. 0046



PL 15 kabel

15 m antenna extension cable 5 mm 50 Ω
15 meter RG58 antenne forlænger kabel med PL259
No. 0047



Import og distribution:
DANITAS RADIO A/S
Hammershusgade 11,
DK- 2100 Copenhagen, Denmark.
Tel 39 20 00 31 Fax 39 20 00 40
e-mail: info@danitas.com
www.danitas.com