

PRESIDENT

WALKER

SERVICE MANUAL



-TECNNICAL CHARACTERITICS

1-GENERAL:

-Multiconfiguration(E,d,EU,EC,U,PL)

- E ⇒ 40 channels AM/FM 4W (from 26,965Mhz to 27,405Mhz)
- d ⇒ 80 channels FM 4W/AM 1W (from 26,565Mhz to 27,405Mhz)
- EU ⇒ 40 channels FM 4W/AM 1W (from 26,965Mhz to 27,405Mhz)
- EC ⇒ 40 channels FM 4W (from 26,965Mhz to 27,405Mhz)
- U ⇒ 40 channels FM 4W (from 26,965Mhz to 27,405Mhz)
40 channels FM 4W (from 27,60125Mhz to 27,99125Mhz)
- PL ⇒ 40 channels AM/FM 4W (from 26,960Mhz to 27,400Mhz)

-Channel step

-10KHz

-Class of emission

-AM(A3E)/FM(F3E)

-Power supply

-13,2V (from 10,8V to 15,6V)

-Antenna impedance

-50Ω

-Dimensions(in mm)

-160(L)x160(H)x55(D)

-Weight

-1,1Kg

2-TRANSMISSION:

-Frequency allowance

-±300Hz

-Transmission interference

-Inferior to 4nW(-54dBm)

-Audio frequency response

-From 300Hz to 3kHz in AM/FM

-Emitted power in the adjacent channel

-Inferior to 20μW

-Microphone sensitivity

-Inferior to 10mV

-Current drain

-2A(in transmission mode with modulation)

-Modulated signal distortion

-Inferior to 2%

3-RECEPTION:

-Maximum sensitivity at 20dB sinad

-0,5 μ V(-113dBm) AM/FM

-Audio frequency response

-From 300Hz to 3kHz in AM/FM

-Adjacent channel selectivity

-Superior to 60dB

-Frequency image rejection

-Superior to 60dB

-Intermodulation response

-Superior to 54dB

-Maximum audio power

-5W

-Squelch sensitivity

-Threshold 0,2 μ V(-120dBm)/Tight 1mV(-47dBm)

-Current drain

-400mA nominal/1500mA maximum

ALIGNMENT PROCEDURE (WALKER)

* VCO/PLL PORTION

- Alignment procedure
- Test points
- Frequencies chart

* TRANSMITTER

- Alignment procedure
- Test points

* RECEIVER

- Alignment procedure
- Test points

Test equipment required

Frequency counter 200 Mhz	HF Generator
DC Voltmeter	BF Voltmeter
Distortimeter	HF Voltmeter
Wattmeter - Dummy load	Osilloscope
FM linear detector	Load 8 Ω
AF generator	Sinad meter

Conditions of Measurements on HF Generator

Reception

AM mode: Level - 107 dBm Frequency 1 KHz with 60% of modulation.

FM mode: Level - 107 dBm Frequency 1 KHz with 1,2KHz of deviation.

Transmission

Frequency 1 KHz 30mV.

ALIGNMENT VCO/PLL

1 - Alignment procedure(13,2V;configuration"EU,E,d")

STEP	CONDITION	ADJUSTMENT	REMARKS OF ADJUSTMENT
1	FM(EU,E) TX mode Channel 40	L302	Connect a voltmeter to TP 301, adjust L302 to reach $2V \pm 0,2V$.
2	FM(EU,E) RX mode Channel 40	L301	Connect a voltmeter to TP 301, adjust L301 to reach $2,5V \pm 0,2V$.
3	FM(EU,E) TX/RX mode Channel 1		Connect a voltmeter to TP 301,and check: Rx Channel 1= $2,2V \pm 0,2V$ Tx Channel 1= $1,8V \pm 0,2V$
4	FM(EU,E) RX mode Channel 20	CT301	Connect a frequency counter to TP302,and adjust CT301 to reach 37,900MHz.
5	FM(EU,E) TX/RX mode Channel 1 to 40 or 1 to 80(d)		Connect a frequency counter to TP302,and check frequencies.

Use Pb free Solder

B001 PA-437AA (TOP VIEW)

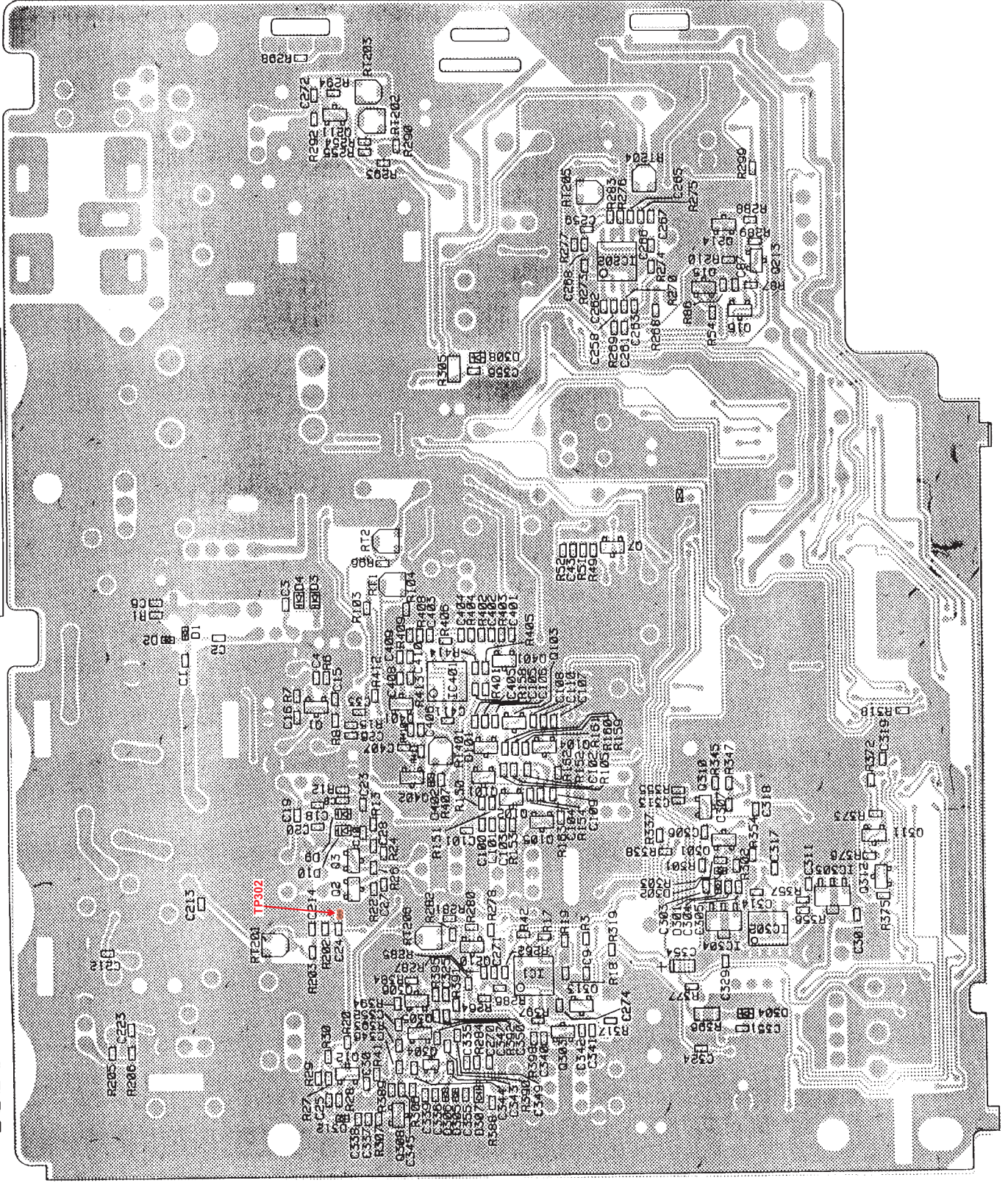

Use Pb fr

HEAT SINK: HHSK352588Z

B001 PA-437AA (TOP VIEW)

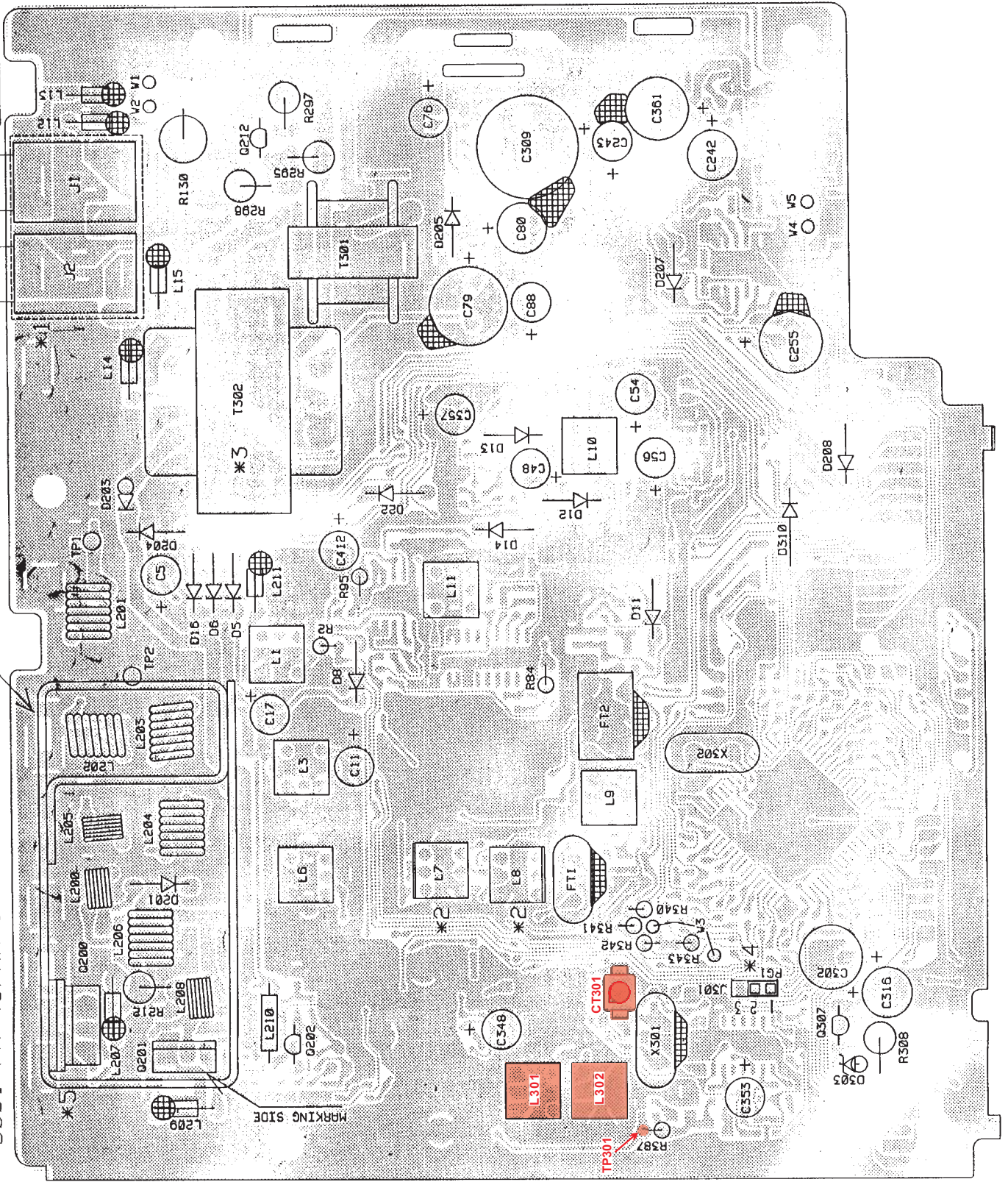

- FREQUENCY LIST (EU,E,EC)

CH	Channels Frequencies (MHz)	VCO Frequencies (MHz)
1	26,965	37,660
2	26,975	37,670
3	26,985	37,680
4	27,005	37,700
5	27,015	37,710
6	27,025	37,720
7	27,035	37,730
8	27,055	37,750
9	27,065	37,760
10	27,075	37,770
11	27,085	37,780
12	27,105	37,800
13	27,115	37,810
14	27,125	37,820
15	27,135	37,830
16	27,155	37,850
17	27,165	37,860
18	27,175	37,870
19	27,185	37,880
20	27,205	37,900
21	27,215	37,910
22	27,225	37,930
23	27,255	37,950
24	27,235	37,930
25	27,245	37,940
26	27,265	37,960
27	27,275	37,970
28	27,285	37,980
29	27,295	37,990
30	27,305	38,000
31	27,315	38,010
32	27,325	38,020
33	27,335	38,030
34	27,345	38,040
35	27,355	38,050
36	27,365	38,060
37	27,375	38,070
38	27,385	38,080
39	27,395	38,090
40	27,405	38,100

- FREQUENCY LIST (PL)

CH	Channels Frequencies (MHz)	VCO Frequencies (MHz)
1	26,960	37,655
2	26,970	37,665
3	26,980	37,675
4	27,000	37,695
5	27,010	37,705
6	27,020	37,715
7	27,030	37,725
8	27,050	37,745
9	27,060	37,755
10	27,070	37,765
11	27,080	37,775
12	27,100	37,795
13	27,110	37,805
14	27,120	37,815
15	27,130	37,825
16	27,150	37,845
17	27,160	37,855
18	27,170	37,865
19	27,180	37,875
20	27,200	37,895
21	27,210	37,905
22	27,220	37,915
23	27,250	37,945
24	27,230	37,925
25	27,240	37,935
26	27,260	37,955
27	27,270	37,965
28	27,280	37,975
29	27,290	37,985
30	27,300	37,995
31	27,310	38,005
32	27,320	38,015
33	27,330	38,025
34	27,340	38,035
35	27,350	38,045
36	27,360	38,055
37	27,370	38,065
38	27,380	38,075
39	27,390	38,085
40	27,400	38,095

- FREQUENCY LIST (U)

CH CEPT	Channels Frequencies (MHz)	VCO Frequencies (MHz)
1	26,965	37,660
2	26,975	37,670
3	26,985	37,680
4	27,005	37,700
5	27,015	37,710
6	27,025	37,720
7	27,035	37,730
8	27,055	37,750
9	27,065	37,760
10	27,075	37,770
11	27,085	37,780
12	27,105	37,800
13	27,115	37,810
14	27,125	37,820
15	27,135	37,830
16	27,155	37,850
17	27,165	37,860
18	27,175	37,870
19	27,185	37,880
20	27,205	37,900
21	27,215	37,910
22	27,225	37,930
23	27,255	37,950
24	27,235	37,930
25	27,245	37,940
26	27,265	37,960
27	27,275	37,970
28	27,285	37,980
29	27,295	37,990
30	27,305	38,000
31	27,315	38,010
32	27,325	38,020
33	27,335	38,030
34	27,345	38,040
35	27,355	38,050
36	27,365	38,060
37	27,375	38,070
38	27,385	38,080
39	27,395	38,090
40	27,405	38,100

- FREQUENCY LIST (U)

CH ENG	Channels Frequencies (MHz)	VCO Frequencies (MHz)
1	27,60125	38,29625
2	27,61125	38,30625
3	27,62125	38,31625
4	27,63125	38,32625
5	27,64125	38,33625
6	27,65125	38,34625
7	27,66125	38,35625
8	27,67125	38,36625
9	27,68125	38,37625
10	27,69125	38,38625
11	27,70125	38,39625
12	27,71125	38,40625
13	27,72125	38,41625
14	27,73125	38,42625
15	27,74125	38,43625
16	27,75125	38,44625
17	27,76125	38,45625
18	27,77125	38,46625
19	27,78125	38,47625
20	27,79125	38,48625
21	27,80125	38,49625
22	27,81125	38,50625
23	27,82125	38,51625
24	27,83125	38,52625
25	27,84125	38,53625
26	27,85125	38,54625
27	27,86125	38,55625
28	27,87125	38,56625
29	27,88125	38,57625
30	27,89125	38,58625
31	27,90125	38,59625
32	27,91125	38,60625
33	27,92125	38,61625
34	27,93125	38,62625
35	27,94125	38,63625
36	27,95125	38,64625
37	27,96125	38,65625
38	27,97125	38,66625
39	27,98125	38,67625
40	27,99125	38,68625

- FREQUENCY LIST (d)

CH	Channels	VCO	CH	Channels	VCO
d	Frequencies (MHz)	Frequencies (MHz)	D	Frequencies (MHz)	Frequencies (MHz)
1	26,965	37,660	41	26,565	37,260
2	26,975	37,670	42	26,575	37,270
3	26,985	37,680	43	26,585	37,280
4	27,005	37,70	44	26,595	37,290
5	27,015	37,710	45	26,605	37,300
6	27,025	37,720	46	26,615	37,310
7	27,035	37,730	47	26,625	37,320
8	27,055	37,750	48	26,635	37,330
9	27,065	37,760	49	26,645	37,340
10	27,075	37,770	50	26,655	37,350
11	27,085	37,780	51	26,665	37,360
12	27,105	37,800	52	26,675	37,370
13	27,115	37,810	53	26,685	37,380
14	27,125	37,820	54	26,695	37,390
15	27,135	37,830	55	26,705	37,400
16	27,155	37,850	56	26,715	37,410
17	27,165	37,860	57	26,725	37,420
18	27,175	37,870	58	26,735	37,430
19	27,185	37,880	59	26,745	37,440
20	27,205	37,900	60	26,755	37,450
21	27,215	37,910	61	26,765	37,460
22	27,225	37,930	62	26,775	37,470
23	27,255	37,950	63	26,785	37,480
24	27,235	37,930	64	26,795	37,490
25	27,245	37,940	65	26,805	37,500
26	27,265	37,960	66	26,815	37,510
27	27,275	37,970	67	26,825	37,520
28	27,285	37,980	68	26,835	37,530
29	27,295	37,990	69	26,845	37,540
30	27,305	38,000	70	26,855	37,550
31	27,315	38,010	71	26,865	37,560
32	27,325	38,020	72	26,875	37,570
33	27,335	38,030	73	26,885	37,580
34	27,345	38,040	74	26,895	37,590
35	27,355	38,050	75	26,905	37,600
36	27,365	38,060	76	26,915	37,610
37	27,375	38,070	77	26,925	37,620
38	27,385	38,080	78	26,935	37,630
39	27,395	38,090	79	26,945	37,640
40	27,405	38,100	80	26,955	37,650

ALIGNMENT TRANSMITTER

1 - Alignment procedure(13,2V;configuration"EU,E")

STEP	CONDITION	ADJUSTMENT	REMARKS OF ADJUSTMENT
1	AM(EU) Channel 20	RT202(LOW)	Connect a wattmeter to jack antenna, adjust RT202 to reach 1W on the wattmeter.
2	FM(EU) Channel 20	RT203(HI)	Connect a wattmeter to jack antenna, adjust RT203 to reach 4W on the wattmeter.
3	Same as 2	RT201(RF-M)	Adjust RT201 so that S9 on RFmeter.
4	FM(EU) Mod 30 mV 1 KHz CH 20	RT206(DEV)	Adjust RT206 to reach +/- 1,5KHz of deviation.
5	AM(EU) Mod 30 mV 1 KHz CH 20	RT204(AMC)	Adjust RT204 to reach +/- 90% of modulation.
6	AM(E) Mod 30 mV 1 KHz CH 20	RT205(ALC)	Adjust RT205 to reach +/- 90% of modulation.

Use Pb free Solder

B001 PA-437AA (TOP VIEW)

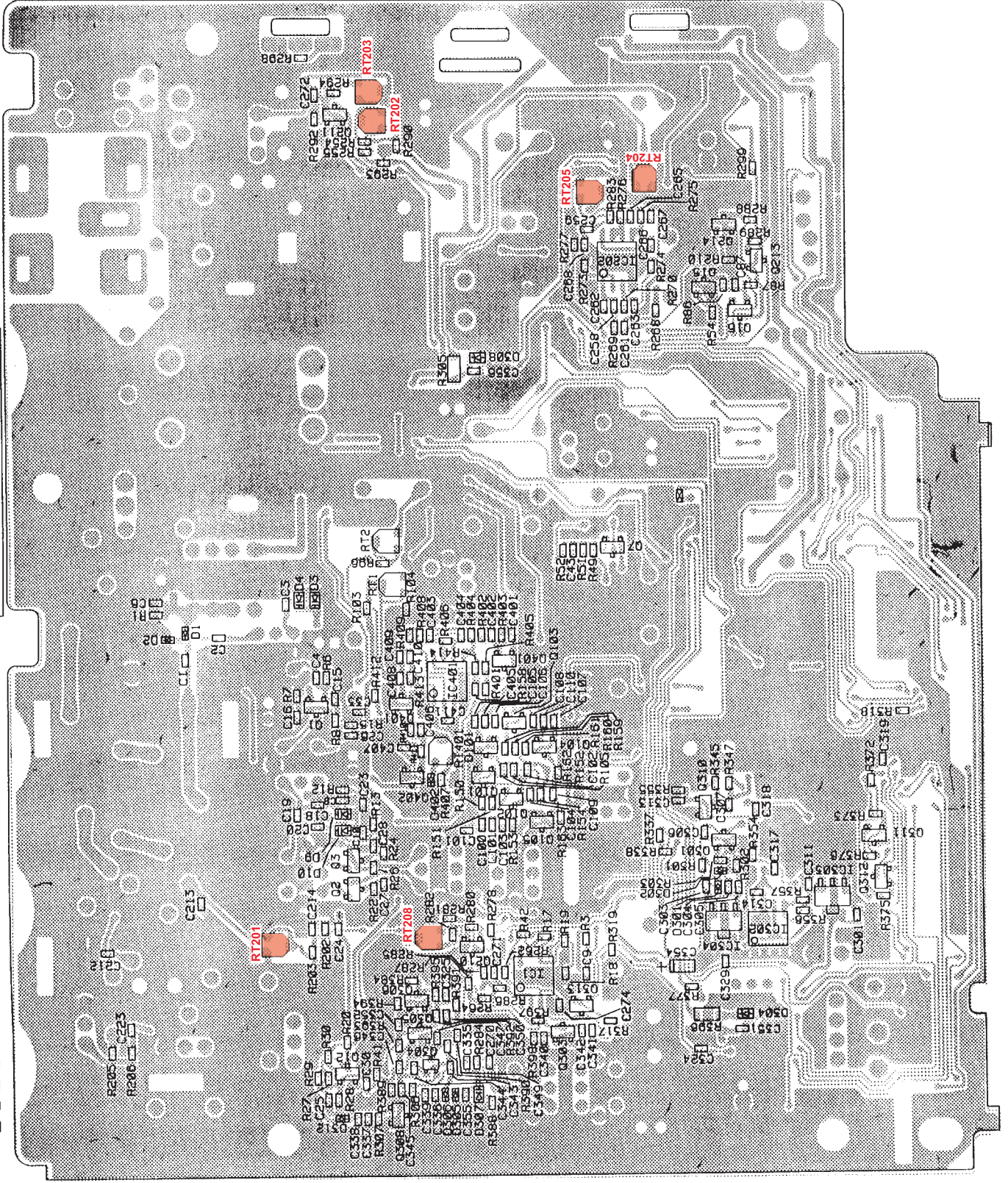

ALIGNMENT RECEIVER

1 - Alignment procedure(13,2V;configuration"EU,E,d")

STEP	CONDITION	ADJUSTMENT	REMARKS OF ADJUSTMENT
1	AM(EU,E) Channel 20 Middle volume level. No squelch active	L1-L3-L6 L7-L8-L9-L10	Connect HF generator to jack antenna adjusted at (-107dBm 1KHz 60%), connect sinad meter to jack EXT speaker and adjust coils for maximum sensitivity(≥ 20 dB sinad).
2	FM(EU,E) Channel 20 Middle volume level No squelch active	L 11	Connect HF generator to jack antenna adjusted at (-107dBm 1KHz 1,2KHz Dev),connect sinad meter to jack EXT speaker and adjust L11 for maximum sensitivity(≥ 20 dB sinad).
3	AM(EU,E) Channel 20 Middle volume level No squelch active	RT2(S-METER)	Connect HF generator to jack antenna adjusted at (-67dBm 1KHz 60%) and adjust RT2 so that S9 on Smeter.
4	AM(EU,E) Channel 20 Middle volume level Squelch maximum clockwise	RT1(SQ)	Connect HF generator to jack antenna adjusted at (-47dBm 1KHz 60%) and adjust RT1 so that the signal is audible .
5	AM(EU,E) Channel 20 Middle volume level Squelch maximum counterclockwise (ASC)	RT401(ASC)	Connect HF generator to jack antenna . Connect sinad meter to jack EXT speaker, adjust the ouput level of HF generator and adjust RT401 to reach at the opening ASC a sinad of $17\text{dB} \pm 2\text{dB}$.

Use Pb free Solder

B001 PA-437AA (TOP VIEW)

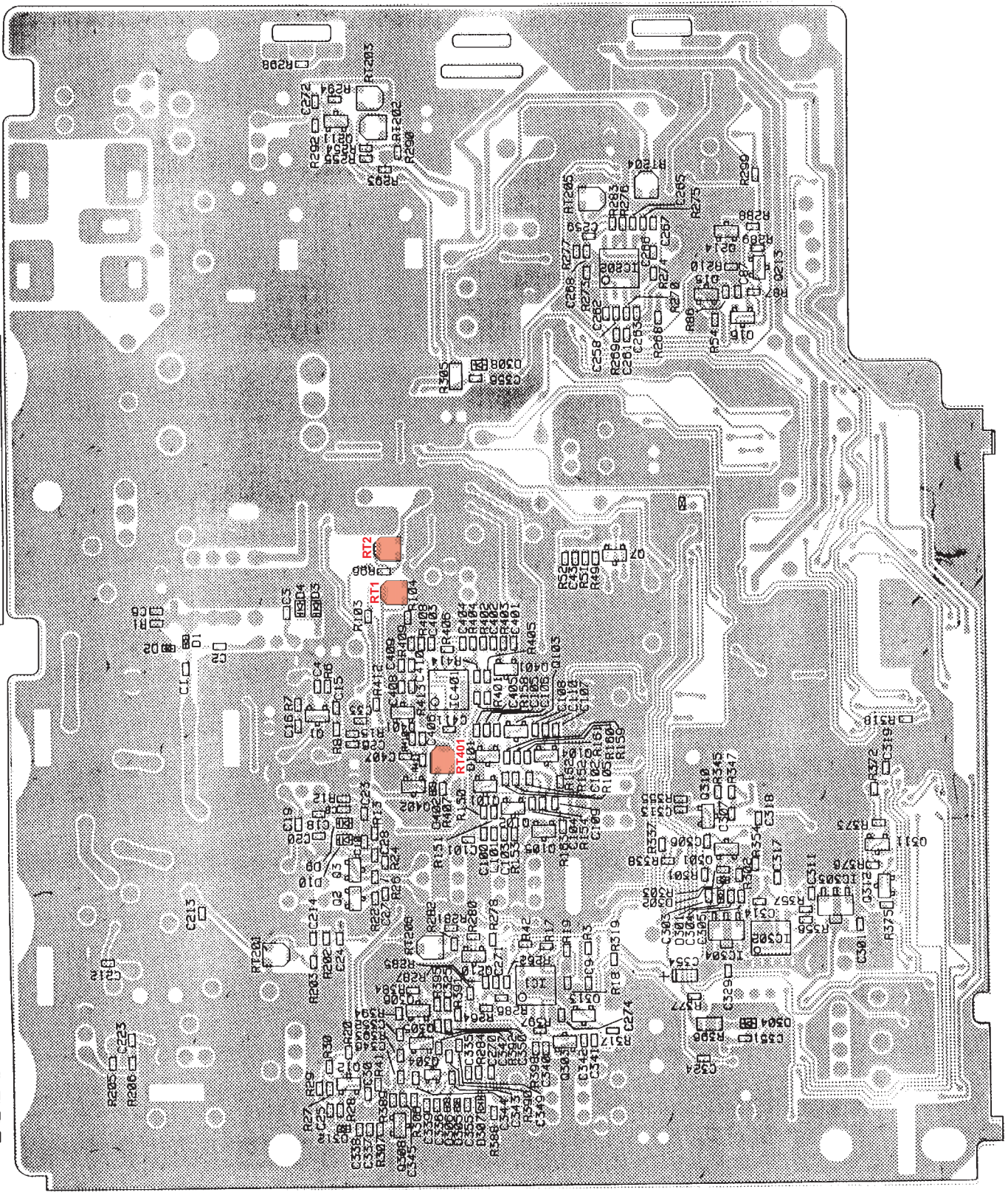

Use Pb fr

HEAT SINK: HHSK352588Z

B001 PA-437AA (TOP VIEW)

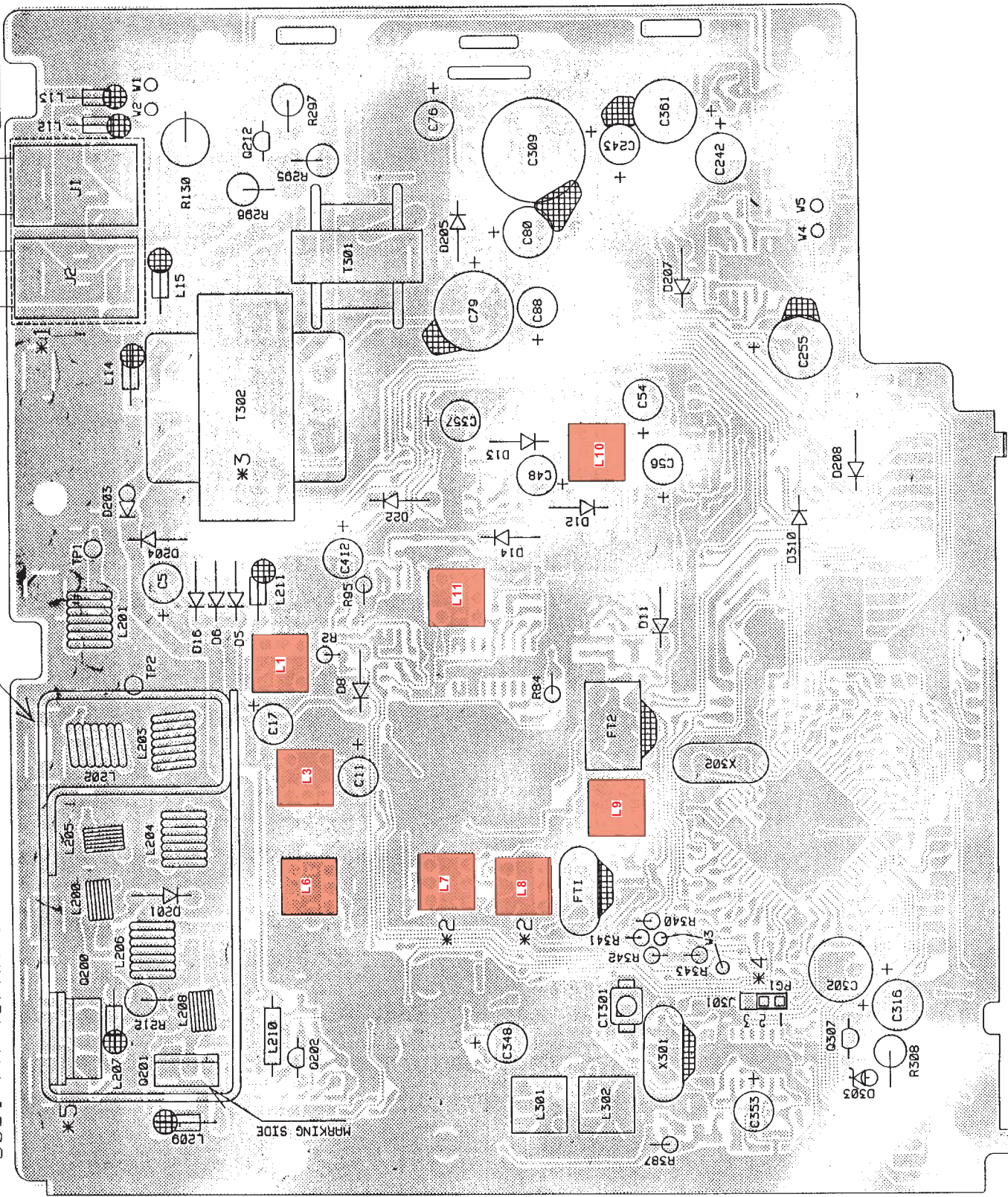

MARKING SIDE

WALKER

BLOC DIAGRAM

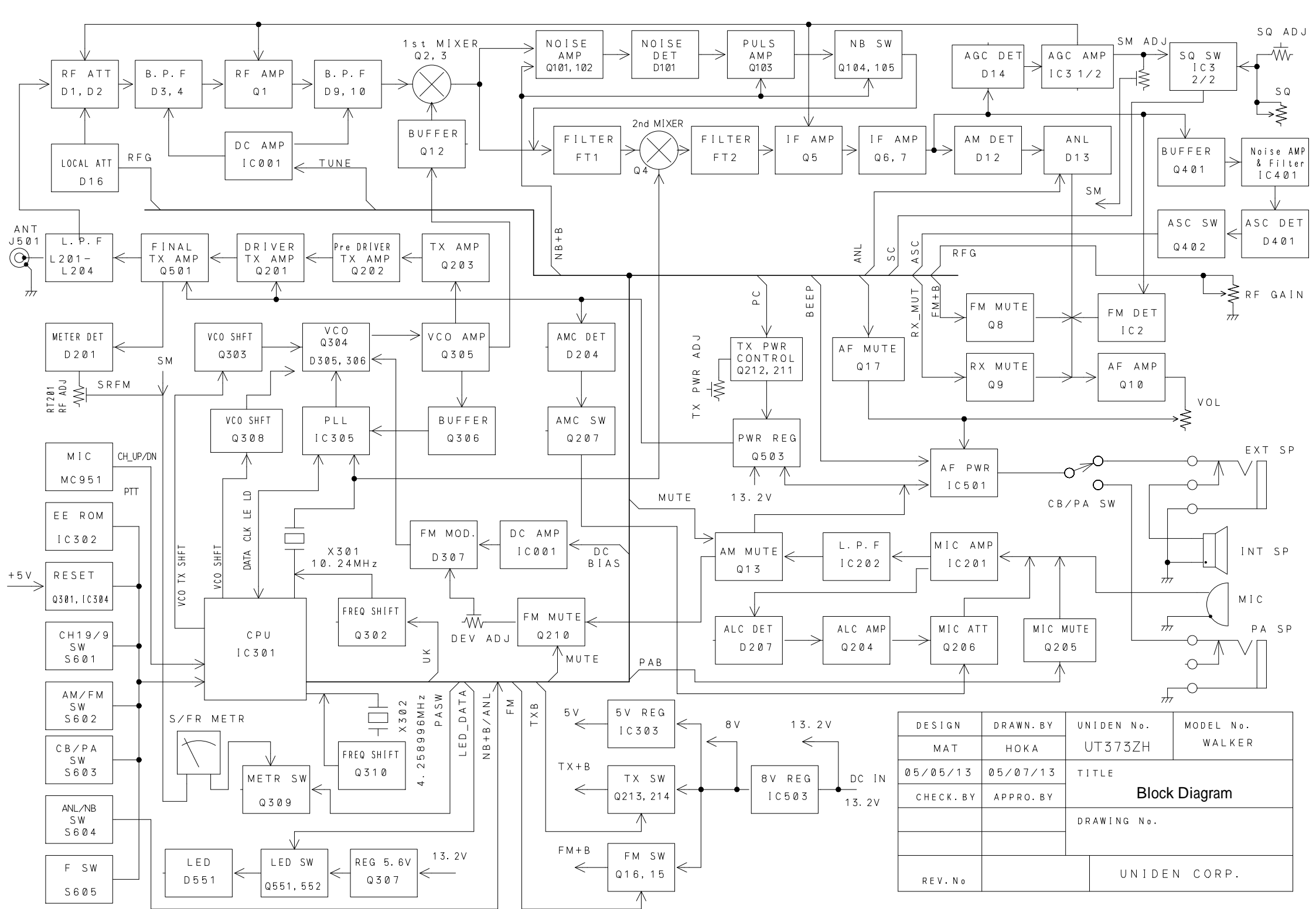

DESIGN	DRAWN BY	UNIDEN No.	MODEL No.
MAT	HOKA	UT373ZH	WALKER
05/05/13	05/07/13	TITLE	
CHECK BY	APPRO BY	Block Diagram	
		DRAWING No.	
REV. No		UNIDEN CORP.	

WALKER

SCHEMATIC DIAGRAM

WALKER

COMPONENT LAYOUT

B001 PA-437AA (TOP VIEW) HEAT SINK: HHSK352588Z

Use Pb free Solder

*1 PUT JAPANESE TAPE UNDER J1 & J2

*2 MARKING SIDE

*5 MARKING SIDE

*3

BEND

*5

HEAT SINK
INSULATION SHEET Y501 YY-027
INSULATION SHEET Y502 YY-027
BUSHING Y1501 YD-019
Q200
B001

* APPLY THERMAL COMPOUND Y501, 502: BOTH SIDE

* YELLOW BOND LOCK(SC-121)

*4 PG1

J301
B001

1 2 3

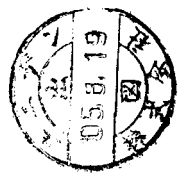
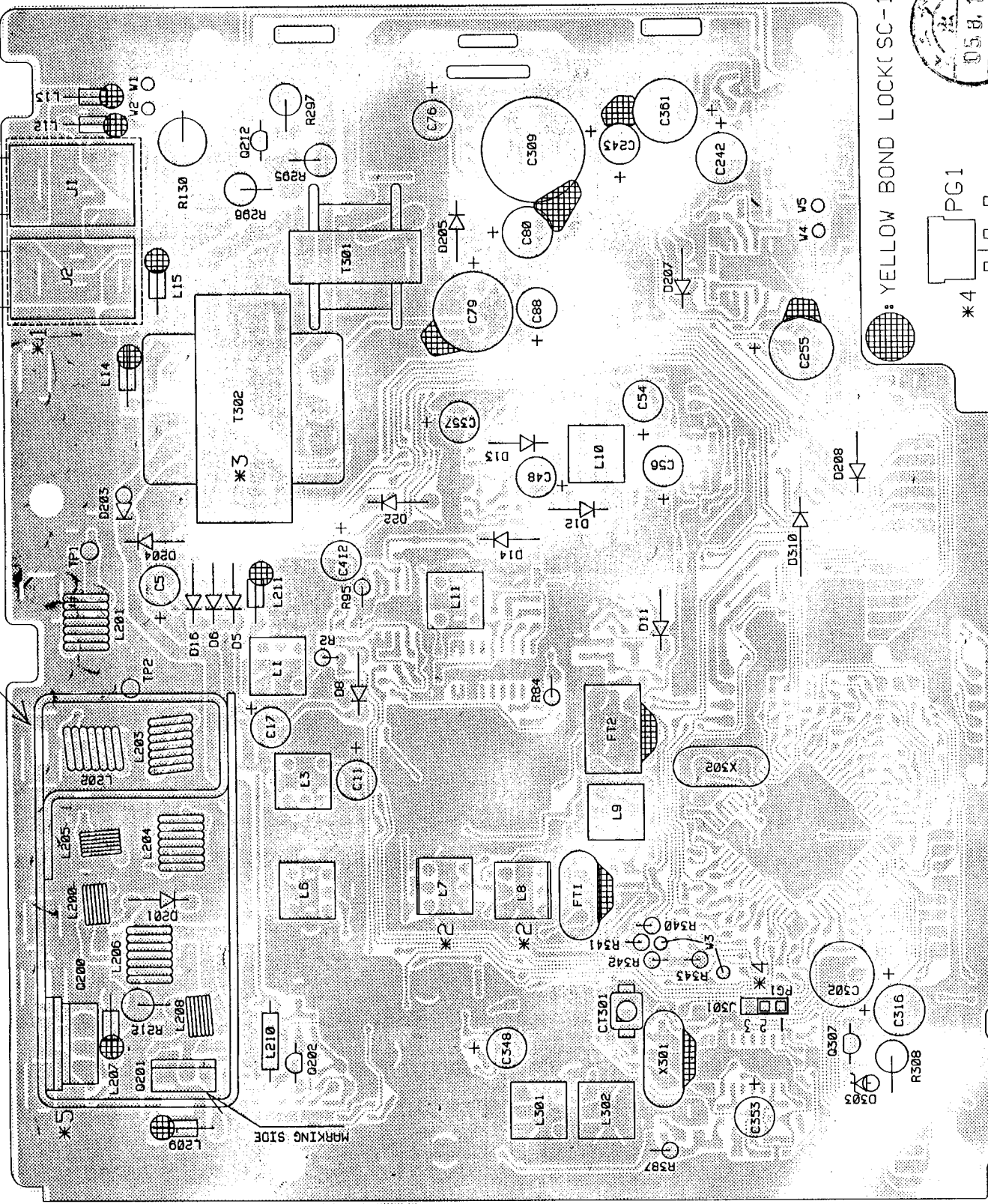

DESIGN BY	UNIDEN NO.	MODEL NO.
2015.8.19	UT5752H	WALKER
CHECK BY	TITLE	MAIN PCB
15.8.19	PARTS ASS'Y	TOP VIEW
APPROV. BY	DRAWING NO.	
A. Ando	E23-25273	
REV. NO.	UNIDEN CORP.	

REV. CODE	REVISIONS
DATE	
LOT #/RN#	
REVISED BY	
CHECKED BY	

C1	27P	C338	0.01	Q103	25C3052-T112-1F	R254	270	R407	56K
C2	0.001	C339	9P	Q104	25A1235A-T112-1F	R255	270	R408	2.2K
C3	470P	C340	0.01	Q105	25C2714-Y(TE85L,F)	R256	1K	R409	390
C4	470P	C341	0.1	Q211	25C3052-T112-1F	R254	56K	R410	10K
C5	0.001	C342	0.01	Q212	25C3052-T112-1F	R258	10K	R411	10K
C6	10P	C343	22P	Q213	25A1235A-T112-1F	R259	10K	R412	560K
C7	0.1	C344	150P	Q214	25C3052-T112-1F	R270	10K	R413	68K
C8	56P	C345	150P	Q303	25D1048-6-TB-E	R274	10K	R414	10K
C9	180P	C346	10P	Q304	25C5063-Y(TE85R,F)	R275	10K		
C10	SP	C347	0.01	Q305	25C2714-Y(TE85L,F)	R276	2.2K		
C11	0.001	C348	0.01	Q306	25C2714-Y(TE85L,F)	R277	1.5K		
C12	0.001	C349	0.01	Q308	25C2714-Y(TE85L,F)	R278	5.5K		
C13	0.01	C350	0.01	Q310	25C2714-Y(TE85L,F)	R280	10K		
C14	0.001	C351	0.01	Q401	25C3052-T112-1F	R281	330		
C15	0.001	C352	2P	Q402	25C3052-T112-1F	R282	100		
C16	0.001	C353	22P	Q311	25A1235A-T112-1F	R283	47K		
C17	0.01	C354	10V 10 C-0345	Q312	25A1235A-T112-1F	R284	10K		
C18	180P	C355	22P	Q313	25C3052-T112-1F	R285	10K		
C19	2P	C356	0.1	Q401	25C3052-T112-1F	R286	1K		
C20	180P	C402	0.01	Q402	25C3052-T112-1F	R287	2.2K		
C21	0.01	C403	0.0047			R288	3.3K		
C22	0.01	C404	0.0047			R289	47K		
C23	0.01	C405	0.1	R1	10K	R290	1K		
C24	0.001	C406	1	R3	47	R291	10K		
C25	0.01	C407	1	R6	2.2K	R292	10K		
C26	0.01	C408	0.047	R7	560	R293	5.6K		
C27	0.01	C409	0.0047	R8	10K	R294	1.5K		
C28	0.01	C410	0.0047	R12	100K	R298	47K		
C29	0.01	C411	1	R13	100K	R301	22K		
C30	0.001			R15	220	R302	10K		
C31	0.01			R17	10K	R303	10K		
C32	0.01			R18	10K	R305	560 1/8W 3216		
C33	0.01			R19	68K	R306	47K		
C34	0.01			R20	22	R307	10K		
C35	0.01			R22	270	R317	1.5K		
C36	0.01			R24	270	R318	3.3K		
C37	0.01			R25	6.8K	R319	10K		
C38	0.01			R27	56K	R322	10K		
C39	0.01			R28	15K	R338	10K		
C40	0.01			R29	220	R345	100K		
C41	0.01			R30	220	R354	3.3K		
C42	0.02			R31	560	R355	10K		
C43	0.02			R42	1K	R356	10K		
C44	0.018			R49	47K	R372	3.3K		
C45	0.056			R51	10	R373	10K		
C46	0.1			R52	150	R375	47K		
C47	820P			R54	10K	R377	56K		
C48	0.01			R56	100	R388	1K		
C49	0.01			R87	10K	R389	270		
C50	0.01			R96	560	R390	22K		
C51	0.01			R103	5.6K	R391	22K		
C52	0.01			R104	3.3K	R392	390		
C53	0.01			R105	3.3K	R393	47K		
C54	0.022			R150	15K	R395	470		
C55	0.1			R151	47K	R396	82 1/8W 3216		
C56	0.022			R153	1K	R397	47K		
C57	120P			R154	180	R401	220K		
C58	0.1			R158	1M	R402	2.7K		
C59	0.1			R159	150K	R403	5.6K		
C60	0.1			R160	10K	R404	390		
C61	0.1			R161	10K	R405	10K		
C62	0.1			R162	47K	R406	68K		
C63	0.1			R163	100K				
C64	0.001			R202	100K				
C65	0.01			R203	5.6K				
C66	0.001			Q15	25C3052-T112-1F				
C67	8P			Q16	25C3052-T112-1F				
C68	3P			Q101	25C2714-Y(TE85L,F)				
C69	0.1			Q102	25C2714-Y(TE85L,F)				

NOTES - chip top:
 1. RESISTANCE VALUES ARE SHOWN IN OHMS UNLESS OTHERWISE NOTED.
 (K-KILO OHM, M-MEG OHM.)
 2. RESISTOR WATTAGES ARE 1/16W UNLESS OTHERWISE NOTED.
 3. CAPACITANCE VALUES ARE INDICATED IN MICRO FARADS UNLESS OTHERWISE NOTED. (P-PICO-FARAD)
 4. ALL CAPACITORS TEMPERATURE CHARACTERISTICS ARE CH (LESS THAN 1000PF) OR B (MORE THAN 1000PF) UNLESS OTHERWISE NOTED.
 5. ALL CAPACITORS SIZE ARE 1608 UNLESS OTHERWISE NOTED.
 6. CHIP PARTS ARE NOT SPECIFIED IN THIS DRAWING PLEASE REFER TO THE PARTS LIST FOR THE CHIP PARTS.

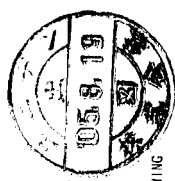

DESIGN BY	UNIDEN NO.	MODEL NO.
2005/8/19	UT373ZH	WALKER
CHECK BY	APPRO. BY	TITLE
4.0.0	4.0.0	MAIN ASSY
4.0.0	4.0.0	CHIP LAY OUT TOP VIEW
REV.	DRAWING NO.	
4.0.0	E-23-25276	
		UNIDEN CORP.

Use Pb free Solder

B001 PA-437AA (BOTTOM VIEW)

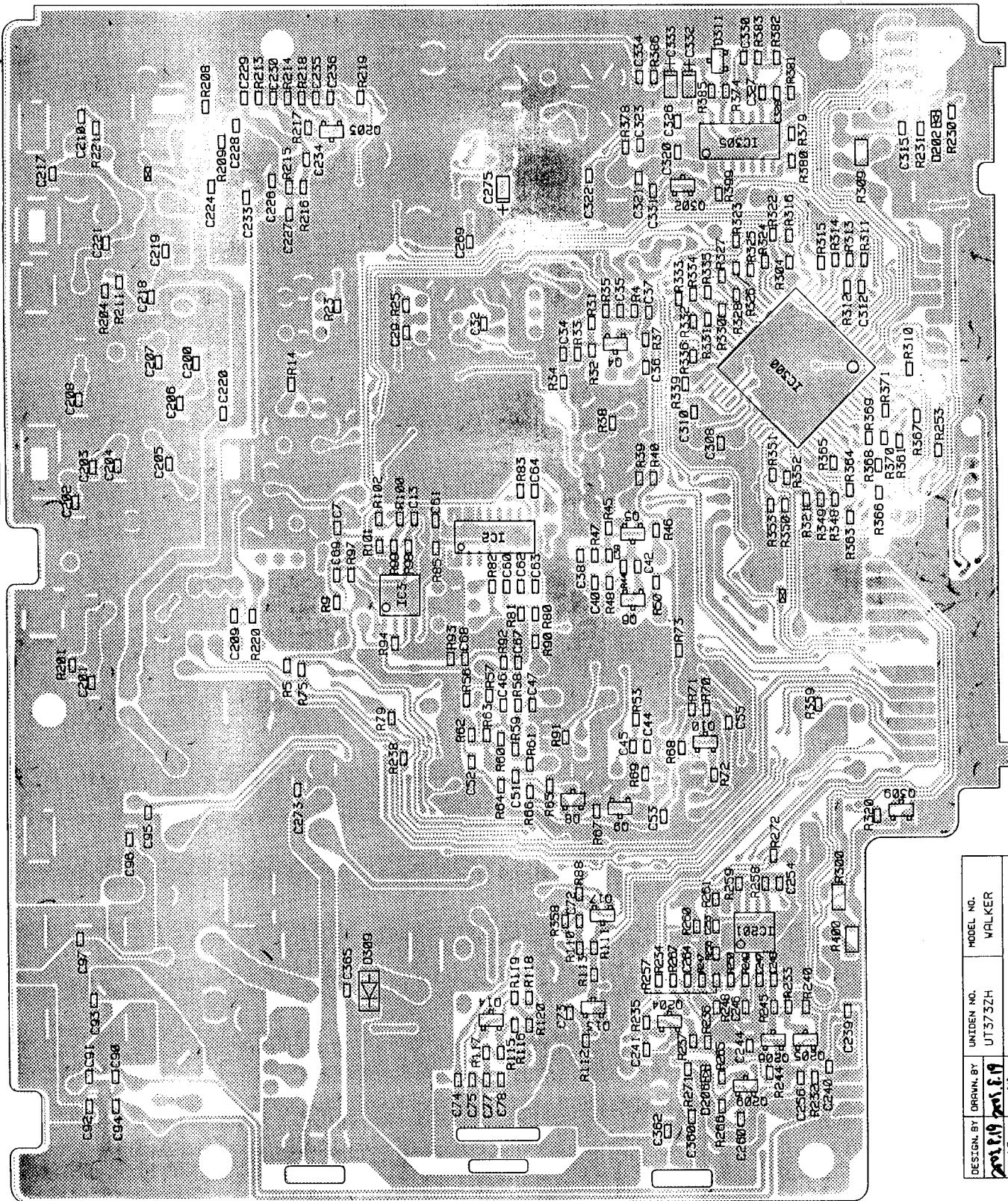

DESIGN BY	UNIDEN NO.	MODEL NO.
201.8.19	UT 3732H	WALKER
CHECK BY	TITLE	1/2
H. Hata	MAIN PCB	
25.8.19	CHIP LAYOUT BOTTOM VIEW	
REV. NO.	DRAWING NO.	
	E23-25277	
		UNIDEN CORP.



REV. CODE	
DATE	
LOT#/RN#	
REVISED BY	
CHECKED BY	

Use Pb free Solder

B801 PA-438AA 1/6 (BOTTOM VIEW)

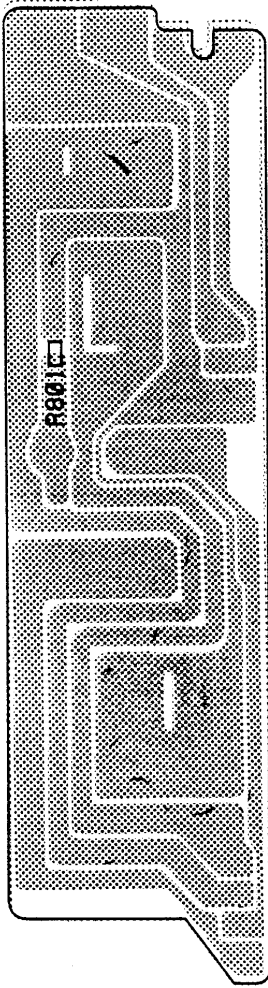

R801 220

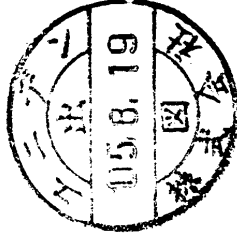

NOTES:

- 1. RESISTANCE VALUES ARE SHOWN IN OHMS UNLESS OTHERWISE NOTED. (K-KILO OHM, M-MEG OHM)
- 2. RESISTOR WATTAGES ARE 1/16W UNLESS OTHERWISE NOTED.

REV. CODE	△	△	△	△	△	△	△	△	△	△	△	△	△	△	△	△	△	△	△	△
DATE																				
LOT#/RN#																				
REVISED BY																				
CHECKED BY																				

DESIGN. BY <i>2015.8.19 josh.p.f.</i>	DRAWN. BY <i>2015.8.19 josh.p.f.</i>	UNIDEN NO. UT373ZH	MODEL NO. WALKER
<i>Hokka</i>	<i>Hokka</i>	TITLE VOL PCB	
CHECK. BY <i>M. Matsumoto</i>	APPRO. BY <i>M. Matsumoto</i>	CHIP LAYOUT BOTTOM VIEW	
<i>05.8.19</i>	<i>05.8.19</i>	DRAWING NO. E24-25280	
REV. NO.		UNIDEN CORP.	

Use Pb free Solder

B601 PA-438AA 2/6 (TOP VIEW)

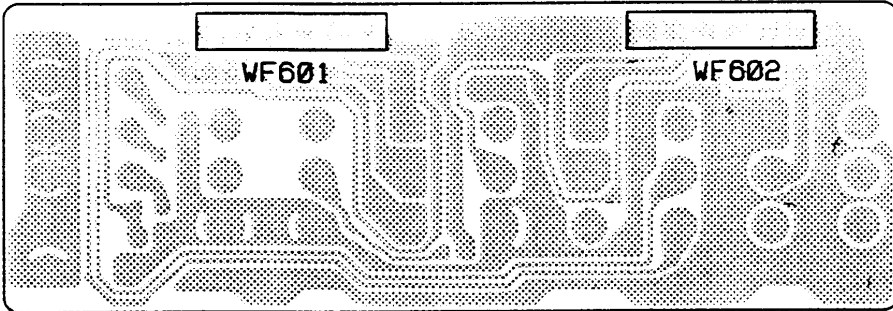

WF601	WF-386 3.5-50-3.5 6P
WF602	WF-386 3.5-50-3.5 6P

REVISIONS	REV. CODE	△	△	△	△	△	△	△	△	△	△	△	△	△	△	△	△	△	△
	DATE																		
	LOT#/RN#																		
	CHECKED BY																		

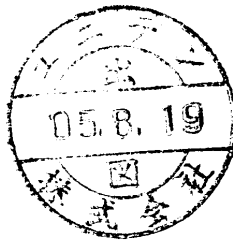

DESIGN. BY	DRAWN. BY	UNIDEN NO.	MODEL NO.
M.S.P.19	M.S.P.19	UT373ZH	WALKER
HECK. BY	APPRO. BY	TITLE SW PCB	
M. Mats	Nabe	PARTS ASS'Y TOP VIEW	
05.8.19	05.8.19	DRAWING NO.	
		E24-25281	
REV. NO.		UNIDEN CORP.	

Use Pb free Solder

B601 PA-438AA 2/6 (BOTTOM VIEW)

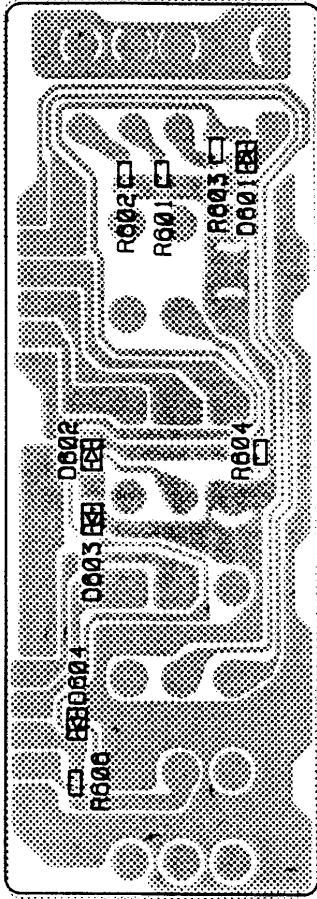

D601	UDZS F 7.5B TE-17
D602	UDZS F 7.5B TE-17
D603	UDZS F 7.5B TE-17
D604	UDZS F 7.5B TE-17
R601	10K
R602	100K
R603	1K
R604	1K
R606	1K

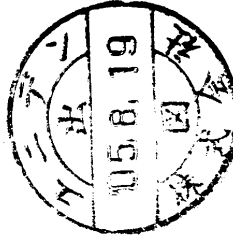

NOTES:

- RESISTANCE VALUES ARE SHOWN IN OHMS UNLESS OTHERWISE NOTED. (K-KILO OHM, M-MEG OHM)
- RESISTOR WATTAGES ARE 1/16W UNLESS OTHERWISE NOTED.

REVISIONS	△	△	△	△	△	△	△	△	△	△	△	△	△	△	△	△	△	△	△	△
DATE																				
LOT#/RN#																				
REVISED BY																				
CHECKED BY																				

DESIGN BY	DRAWN BY	UNIDEN NO.	MODEL NO.
2015.8.19	2015.8.19	UT373ZH	WALKER
CHECK BY	APPRO. BY	TITLE	SM PCB
M. J. J. J.	M. J. J. J.	CHIP LAYOUT BOTTOM VIEW	
REV. NO.	DRAWING NO.		
05.8.19	E24-25282		
	UNIDEN CORP.		

Use Pb free Solder

B701 PA-438AA 5/6 (TOP VIEW)

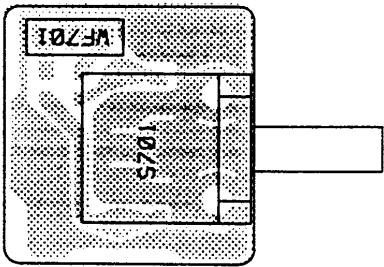

S701	SR-463	SR10030F-40F-F7-008
WF701	WF-383	3.5-55-3.5 3P

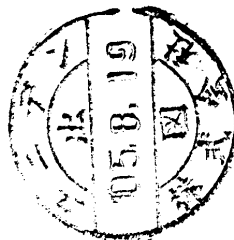

REV. CODE	△	△	△	△	△	△	△	△	△	△	△	△	△	△	△	△	△	△	△	△	△	△
DATE																						
LOT#/RN#																						
REVISED BY																						
CHECKED BY																						

DESIGN. BY 2005.8.19 HOKA	DRAWN. BY 2005.8.19 HOKA	UNIDEN NO. UT373ZH	MODEL NO. WALKER
CHECK. BY H. Maeda	APPRO. BY 2005.8.19 H. Maeda	TITLE CH SW PCB PARTS ASS'Y TOP VIEW	
REV. NO.		DRAWING NO. E24-25287	UNIDEN CORP.

Use Pb free Solder

B701 PA-438AA 5/6 (BOTTOM VIEW)

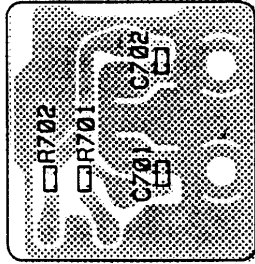

C701	0.01
C702	0.01
R701	1K
R702	1K

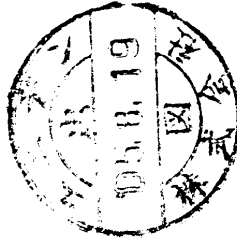

NOTES:

1. RESISTANCE VALUES ARE SHOWN IN OHMS UNLESS OTHERWISE NOTED.
(K-KILO OHM, M-MEG OHM)
2. RESISTOR WATTAGES ARE 1/16W UNLESS OTHERWISE NOTED.
3. CAPACITANCE VALUES ARE INDICATED IN MICRO FARADS UNLESS OTHERWISE NOTED.
(P-MICRO-MICRO FARAD)
4. ALL CAPACITORS TEMPERATURE CHARACTERISTICS ARE B UNLESS OTHERWISE NOTED.

REV. CODE	△	△	△	△	△	△	△	△	△	△	△	△	△	△	△	△	△	△	△	△	
DATE																					
LOT#/RN#																					
REVISED BY																					
CHECKED BY																					

DESIGN. BY	DRAWN. BY	UNIDEN NO.	MODEL NO.
2005.8.19	2005.8.19	UT373ZH	WALKER
HOKA	HOKA	TITLE	CH SW PCB
CHECK. BY	APPRO. BY	CHIP LAYOUT BOTTOM VIEW	
H. HOKA	H. HOKA	DRAWING NO.	E 24-25288
REV. NO.	105.8.19	UNIDEN CORP.	

Use Pb free Solder

B651 PA-438AA 6/6 (TOP VIEW)

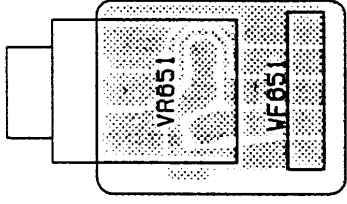

VR651	RV-966	5KB/5KA
VF651	WF-385	3.5-65-3.5 5P

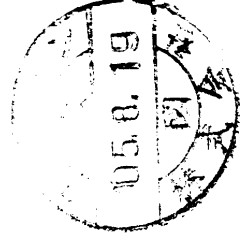

REVISIONS																								
REV. CODE																								
DATE																								
LOT#/RN#																								
REVISED BY																								
CHECKED BY																								

DESIGN. BY	205.8.19	DRWN. BY	205.8.19	UNIDEN NO.	UT373ZH	MODEL NO.	WALKER
CHECK. BY	MWA	APPRO. BY	MWA	TITLE		RF MIC PCB	
				PARTS ASS'Y TOP VIEW			
				DRAWING NO.		E24-25289	
REV. NO.							UNIDEN CORP.

COMPONENTS LIST

WALKER : Bill of Material

ASSY CODE	PARTS CODE	DESCRIPTION	SPEC	REF NO	QTY	REMARKS
AT373ZHBAE	BCAZ111016Z	C:ELECTROLYTIC	100UF 10V M C-156	C011	1	
AT373ZHBAE	BCAZ111016Z	C:ELECTROLYTIC	100UF 10V M C-156	C056	1	
AT373ZHBAE	BCAZ111016Z	C:ELECTROLYTIC	100UF 10V M C-156	C348	1	
AT373ZHBAE	BCAZ112216Z	C:ELECTROLYTIC	220UF 10V M C-156	C080	1	
AT373ZHBAE	BCAZ112216Z	C:ELECTROLYTIC	220UF 10V M C-156	C242	1	
AT373ZHBAE	BCAZ112216Z	C:ELECTROLYTIC	220UF 10V M C-156	C316	1	
AT373ZHBAE	BCAZ114716Z	C:ELECTROLYTIC	470UF 10V M C-156	C255	1	
AT373ZHBAE	BCAZ114716Z	C:ELECTROLYTIC	470UF 10V M C-156	C361	1	
AT373ZHBAE	BCAZ511026Z	C:ELECTROLYTIC	1000UF 25V M C-156	C309	1	
AT373ZHBAE	BCAZ514706Z	C:ELECTROLYTIC	47UF 25V M C-156	C017	1	
AT373ZHBAE	BCAZ514706Z	C:ELECTROLYTIC	47UF 25V M C-156	C076	1	
AT373ZHBAE	BCAZ514706Z	C:ELECTROLYTIC	47UF 25V M C-156	C088	1	
AT373ZHBAE	BCAZ514706Z	C:ELECTROLYTIC	47UF 25V M C-156	C243	1	
AT373ZHBAE	BCAZ514706Z	C:ELECTROLYTIC	47UF 25V M C-156	C353	1	
AT373ZHBAE	BCAZ514716Z	C:ELECTROLYTIC	470UF 25V M C-156	C079	1	
AT373ZHBAE	BCAZ811006Z	C:ELECTROLYTIC	10UF 50V M C-156	C357	1	
AT373ZHBAE	BCAZ811096Z	C:ELECTROLYTIC	1UF 50V M C-156	C412	1	
AT373ZHBAE	BCAZ812206Z	C:ELECTROLYTIC	22UF 50V M C-156	C054	1	
AT373ZHBAE	BCAZ814786Z	C:ELECTROLYTIC	0.47UF 50V M C-156	C048	1	
AT373ZHBAE	BCAZ814796Z	C:ELECTROLYTIC	4.7UF 50V M C-156	C005	1	
AT373ZHBAE	BCAZ904716Z	C:ELECTROLYTIC	470UF 6.3V M C-156	C302	1	
AT373ZHBAE	BCKU111006G	C: TANTALUM CHIP TAPE	10UF 10V M A C-345	C275	1	
AT373ZHBAE	BCKU111006G	C: TANTALUM CHIP TAPE	10UF 10V M A C-345	C354	1	
AT373ZHBAE	BCML111055G	C:CERAMIC M/L (1608) TAPE	1UF 10V K B	C068	1	
AT373ZHBAE	BCML111055G	C:CERAMIC M/L (1608) TAPE	1UF 10V K B	C087	1	
AT373ZHBAE	BCML111055G	C:CERAMIC M/L (1608) TAPE	1UF 10V K B	C246	1	
AT373ZHBAE	BCML111055G	C:CERAMIC M/L (1608) TAPE	1UF 10V K B	C253	1	
AT373ZHBAE	BCML111055G	C:CERAMIC M/L (1608) TAPE	1UF 10V K B	C274	1	
AT373ZHBAE	BCML111055G	C:CERAMIC M/L (1608) TAPE	1UF 10V K B	C406	1	
AT373ZHBAE	BCML111055G	C:CERAMIC M/L (1608) TAPE	1UF 10V K B	C407	1	
AT373ZHBAE	BCML111055G	C:CERAMIC M/L (1608) TAPE	1UF 10V K B	C411	1	
AT373ZHBAE	BCML811025G	C:CERAMIC M/L (1608) TAPE	0.001UF 50V K B	C002	1	
AT373ZHBAE	BCML811025G	C:CERAMIC M/L (1608) TAPE	0.001UF 50V K B	C006	1	
AT373ZHBAE	BCML811025G	C:CERAMIC M/L (1608) TAPE	0.001UF 50V K B	C024	1	
AT373ZHBAE	BCML811025G	C:CERAMIC M/L (1608) TAPE	0.001UF 50V K B	C030	1	
AT373ZHBAE	BCML811025G	C:CERAMIC M/L (1608) TAPE	0.001UF 50V K B	C051	1	
AT373ZHBAE	BCML811025G	C:CERAMIC M/L (1608) TAPE	0.001UF 50V K B	C060	1	
AT373ZHBAE	BCML811025G	C:CERAMIC M/L (1608) TAPE	0.001UF 50V K B	C067	1	
AT373ZHBAE	BCML811025G	C:CERAMIC M/L (1608) TAPE	0.001UF 50V K B	C090	1	
AT373ZHBAE	BCML811025G	C:CERAMIC M/L (1608) TAPE	0.001UF 50V K B	C091	1	
AT373ZHBAE	BCML811025G	C:CERAMIC M/L (1608) TAPE	0.001UF 50V K B	C092	1	
AT373ZHBAE	BCML811025G	C:CERAMIC M/L (1608) TAPE	0.001UF 50V K B	C094	1	
AT373ZHBAE	BCML811025G	C:CERAMIC M/L (1608) TAPE	0.001UF 50V K B	C095	1	

ASSY CODE	PARTS CODE	DESCRIPTION	SPEC	REF NO	QTY	REMARKS
AT373ZHBAE	BCML811025G	C:CERAMIC M/L (1608) TAPE	0.001UF 50V K B	C096	1	
AT373ZHBAE	BCML811025G	C:CERAMIC M/L (1608) TAPE	0.001UF 50V K B	C097	1	
AT373ZHBAE	BCML811025G	C:CERAMIC M/L (1608) TAPE	0.001UF 50V K B	C101	1	
AT373ZHBAE	BCML811025G	C:CERAMIC M/L (1608) TAPE	0.001UF 50V K B	C102	1	
AT373ZHBAE	BCML811025G	C:CERAMIC M/L (1608) TAPE	0.001UF 50V K B	C104	1	
AT373ZHBAE	BCML811025G	C:CERAMIC M/L (1608) TAPE	0.001UF 50V K B	C106	1	
AT373ZHBAE	BCML811025G	C:CERAMIC M/L (1608) TAPE	0.001UF 50V K B	C107	1	
AT373ZHBAE	BCML811025G	C:CERAMIC M/L (1608) TAPE	0.001UF 50V K B	C110	1	
AT373ZHBAE	BCML811025G	C:CERAMIC M/L (1608) TAPE	0.001UF 50V K B	C226	1	
AT373ZHBAE	BCML811025G	C:CERAMIC M/L (1608) TAPE	0.001UF 50V K B	C234	1	
AT373ZHBAE	BCML811025G	C:CERAMIC M/L (1608) TAPE	0.001UF 50V K B	C247	1	
AT373ZHBAE	BCML811025G	C:CERAMIC M/L (1608) TAPE	0.001UF 50V K B	C256	1	
AT373ZHBAE	BCML811025G	C:CERAMIC M/L (1608) TAPE	0.001UF 50V K B	C260	1	
AT373ZHBAE	BCML811025G	C:CERAMIC M/L (1608) TAPE	0.001UF 50V K B	C264	1	
AT373ZHBAE	BCML811025G	C:CERAMIC M/L (1608) TAPE	0.001UF 50V K B	C324	1	
AT373ZHBAE	BCML811025G	C:CERAMIC M/L (1608) TAPE	0.001UF 50V K B	C329	1	
AT373ZHBAE	BCML811025G	C:CERAMIC M/L (1608) TAPE	0.001UF 50V K B	C401	1	
AT373ZHBAE	BCML811025G	C:CERAMIC M/L (1608) TAPE	0.001UF 50V K B	C755	1	
AT373ZHBAE	BCML811025G	C:CERAMIC M/L (1608) TAPE	0.001UF 50V K B	C757	1	
AT373ZHBAE	BCML811035G	C:CERAMIC M/L (1608) TAPE	0.01UF 50V K B	C007	1	
AT373ZHBAE	BCML811035G	C:CERAMIC M/L (1608) TAPE	0.01UF 50V K B	C013	1	
AT373ZHBAE	BCML811035G	C:CERAMIC M/L (1608) TAPE	0.01UF 50V K B	C016	1	
AT373ZHBAE	BCML811035G	C:CERAMIC M/L (1608) TAPE	0.01UF 50V K B	C023	1	
AT373ZHBAE	BCML811035G	C:CERAMIC M/L (1608) TAPE	0.01UF 50V K B	C025	1	
AT373ZHBAE	BCML811035G	C:CERAMIC M/L (1608) TAPE	0.01UF 50V K B	C026	1	
AT373ZHBAE	BCML811035G	C:CERAMIC M/L (1608) TAPE	0.01UF 50V K B	C027	1	
AT373ZHBAE	BCML811035G	C:CERAMIC M/L (1608) TAPE	0.01UF 50V K B	C028	1	
AT373ZHBAE	BCML811035G	C:CERAMIC M/L (1608) TAPE	0.01UF 50V K B	C029	1	
AT373ZHBAE	BCML811035G	C:CERAMIC M/L (1608) TAPE	0.01UF 50V K B	C033	1	
AT373ZHBAE	BCML811035G	C:CERAMIC M/L (1608) TAPE	0.01UF 50V K B	C034	1	
AT373ZHBAE	BCML811035G	C:CERAMIC M/L (1608) TAPE	0.01UF 50V K B	C037	1	
AT373ZHBAE	BCML811035G	C:CERAMIC M/L (1608) TAPE	0.01UF 50V K B	C042	1	
AT373ZHBAE	BCML811035G	C:CERAMIC M/L (1608) TAPE	0.01UF 50V K B	C074	1	
AT373ZHBAE	BCML811035G	C:CERAMIC M/L (1608) TAPE	0.01UF 50V K B	C093	1	
AT373ZHBAE	BCML811035G	C:CERAMIC M/L (1608) TAPE	0.01UF 50V K B	C103	1	
AT373ZHBAE	BCML811035G	C:CERAMIC M/L (1608) TAPE	0.01UF 50V K B	C209	1	
AT373ZHBAE	BCML811035G	C:CERAMIC M/L (1608) TAPE	0.01UF 50V K B	C213	1	
AT373ZHBAE	BCML811035G	C:CERAMIC M/L (1608) TAPE	0.01UF 50V K B	C218	1	
AT373ZHBAE	BCML811035G	C:CERAMIC M/L (1608) TAPE	0.01UF 50V K B	C219	1	
AT373ZHBAE	BCML811035G	C:CERAMIC M/L (1608) TAPE	0.01UF 50V K B	C220	1	
AT373ZHBAE	BCML811035G	C:CERAMIC M/L (1608) TAPE	0.01UF 50V K B	C224	1	
AT373ZHBAE	BCML811035G	C:CERAMIC M/L (1608) TAPE	0.01UF 50V K B	C230	1	
AT373ZHBAE	BCML811035G	C:CERAMIC M/L (1608) TAPE	0.01UF 50V K B	C233	1	
AT373ZHBAE	BCML811035G	C:CERAMIC M/L (1608) TAPE	0.01UF 50V K B	C244	1	
AT373ZHBAE	BCML811035G	C:CERAMIC M/L (1608) TAPE	0.01UF 50V K B	C259	1	

ASSY CODE	PARTS CODE	DESCRIPTION	SPEC	REF NO	QTY	REMARKS
AT373ZHBAE	BCML811035G	C:CERAMIC M/L (1608) TAPE	0.01UF 50V K B	C270	1	
AT373ZHBAE	BCML811035G	C:CERAMIC M/L (1608) TAPE	0.01UF 50V K B	C272	1	
AT373ZHBAE	BCML811035G	C:CERAMIC M/L (1608) TAPE	0.01UF 50V K B	C325	1	
AT373ZHBAE	BCML811035G	C:CERAMIC M/L (1608) TAPE	0.01UF 50V K B	C326	1	
AT373ZHBAE	BCML811035G	C:CERAMIC M/L (1608) TAPE	0.01UF 50V K B	C328	1	
AT373ZHBAE	BCML811035G	C:CERAMIC M/L (1608) TAPE	0.01UF 50V K B	C330	1	
AT373ZHBAE	BCML811035G	C:CERAMIC M/L (1608) TAPE	0.01UF 50V K B	C338	1	
AT373ZHBAE	BCML811035G	C:CERAMIC M/L (1608) TAPE	0.01UF 50V K B	C340	1	
AT373ZHBAE	BCML811035G	C:CERAMIC M/L (1608) TAPE	0.01UF 50V K B	C342	1	
AT373ZHBAE	BCML811035G	C:CERAMIC M/L (1608) TAPE	0.01UF 50V K B	C347	1	
AT373ZHBAE	BCML811035G	C:CERAMIC M/L (1608) TAPE	0.01UF 50V K B	C349	1	
AT373ZHBAE	BCML811035G	C:CERAMIC M/L (1608) TAPE	0.01UF 50V K B	C350	1	
AT373ZHBAE	BCML811035G	C:CERAMIC M/L (1608) TAPE	0.01UF 50V K B	C351	1	
AT373ZHBAE	BCML811035G	C:CERAMIC M/L (1608) TAPE	0.01UF 50V K B	C365	1	
AT373ZHBAE	BCML811035G	C:CERAMIC M/L (1608) TAPE	0.01UF 50V K B	C402	1	
AT373ZHBAE	BCML811035G	C:CERAMIC M/L (1608) TAPE	0.01UF 50V K B	C751	1	
AT373ZHBAE	BCML811035G	C:CERAMIC M/L (1608) TAPE	0.01UF 50V K B	C752	1	
AT373ZHBAE	BCML811035G	C:CERAMIC M/L (1608) TAPE	0.01UF 50V K B	C753	1	
AT373ZHBAE	BCML811035G	C:CERAMIC M/L (1608) TAPE	0.01UF 50V K B	C754	1	
AT373ZHBAE	BCML811035G	C:CERAMIC M/L (1608) TAPE	0.01UF 50V K B	C756	1	
AT373ZHBAE	BCML811035G	C:CERAMIC M/L (1608) TAPE	0.01UF 50V K B	C758	1	
AT373ZHBAE	BCML811035G	C:CERAMIC M/L (1608) TAPE	0.01UF 50V K B	C759	1	
AT373ZHBAE	BCML811035G	C:CERAMIC M/L (1608) TAPE	0.01UF 50V K B	C760	1	
AT373ZHBAE	BCML811035G	C:CERAMIC M/L (1608) TAPE	0.01UF 50V K B	C701	1	
AT373ZHBAE	BCML811035G	C:CERAMIC M/L (1608) TAPE	0.01UF 50V K B	C702	1	
AT373ZHBAE	BCML811045G	C:CERAMIC M/L (1608) TAPE	0.1UF 50V K B	C009	1	
AT373ZHBAE	BCML811045G	C:CERAMIC M/L (1608) TAPE	0.1UF 50V K B	C036	1	
AT373ZHBAE	BCML811045G	C:CERAMIC M/L (1608) TAPE	0.1UF 50V K B	C038	1	
AT373ZHBAE	BCML811045G	C:CERAMIC M/L (1608) TAPE	0.1UF 50V K B	C039	1	
AT373ZHBAE	BCML811045G	C:CERAMIC M/L (1608) TAPE	0.1UF 50V K B	C040	1	
AT373ZHBAE	BCML811045G	C:CERAMIC M/L (1608) TAPE	0.1UF 50V K B	C043	1	
AT373ZHBAE	BCML811045G	C:CERAMIC M/L (1608) TAPE	0.1UF 50V K B	C044	1	
AT373ZHBAE	BCML811045G	C:CERAMIC M/L (1608) TAPE	0.1UF 50V K B	C045	1	
AT373ZHBAE	BCML811045G	C:CERAMIC M/L (1608) TAPE	0.1UF 50V K B	C053	1	
AT373ZHBAE	BCML811045G	C:CERAMIC M/L (1608) TAPE	0.1UF 50V K B	C055	1	
AT373ZHBAE	BCML811045G	C:CERAMIC M/L (1608) TAPE	0.1UF 50V K B	C061	1	
AT373ZHBAE	BCML811045G	C:CERAMIC M/L (1608) TAPE	0.1UF 50V K B	C062	1	
AT373ZHBAE	BCML811045G	C:CERAMIC M/L (1608) TAPE	0.1UF 50V K B	C063	1	
AT373ZHBAE	BCML811045G	C:CERAMIC M/L (1608) TAPE	0.1UF 50V K B	C069	1	
AT373ZHBAE	BCML811045G	C:CERAMIC M/L (1608) TAPE	0.1UF 50V K B	C073	1	
AT373ZHBAE	BCML811045G	C:CERAMIC M/L (1608) TAPE	0.1UF 50V K B	C077	1	
AT373ZHBAE	BCML811045G	C:CERAMIC M/L (1608) TAPE	0.1UF 50V K B	C078	1	
AT373ZHBAE	BCML811045G	C:CERAMIC M/L (1608) TAPE	0.1UF 50V K B	C214	1	
AT373ZHBAE	BCML811045G	C:CERAMIC M/L (1608) TAPE	0.1UF 50V K B	C239	1	
AT373ZHBAE	BCML811045G	C:CERAMIC M/L (1608) TAPE	0.1UF 50V K B	C240	1	

ASSY CODE	PARTS CODE	DESCRIPTION	SPEC	REF NO	QTY	REMARKS
AT373ZHBAE	BCML811045G	C:CERAMIC M/L (1608) TAPE	0.1UF 50V K B	C241	1	
AT373ZHBAE	BCML811045G	C:CERAMIC M/L (1608) TAPE	0.1UF 50V K B	C248	1	
AT373ZHBAE	BCML811045G	C:CERAMIC M/L (1608) TAPE	0.1UF 50V K B	C254	1	
AT373ZHBAE	BCML811045G	C:CERAMIC M/L (1608) TAPE	0.1UF 50V K B	C266	1	
AT373ZHBAE	BCML811045G	C:CERAMIC M/L (1608) TAPE	0.1UF 50V K B	C268	1	
AT373ZHBAE	BCML811045G	C:CERAMIC M/L (1608) TAPE	0.1UF 50V K B	C269	1	
AT373ZHBAE	BCML811045G	C:CERAMIC M/L (1608) TAPE	0.1UF 50V K B	C271	1	
AT373ZHBAE	BCML811045G	C:CERAMIC M/L (1608) TAPE	0.1UF 50V K B	C273	1	
AT373ZHBAE	BCML811045G	C:CERAMIC M/L (1608) TAPE	0.1UF 50V K B	C301	1	
AT373ZHBAE	BCML811045G	C:CERAMIC M/L (1608) TAPE	0.1UF 50V K B	C303	1	
AT373ZHBAE	BCML811045G	C:CERAMIC M/L (1608) TAPE	0.1UF 50V K B	C305	1	
AT373ZHBAE	BCML811045G	C:CERAMIC M/L (1608) TAPE	0.1UF 50V K B	C311	1	
AT373ZHBAE	BCML811045G	C:CERAMIC M/L (1608) TAPE	0.1UF 50V K B	C312	1	
AT373ZHBAE	BCML811045G	C:CERAMIC M/L (1608) TAPE	0.1UF 50V K B	C313	1	
AT373ZHBAE	BCML811045G	C:CERAMIC M/L (1608) TAPE	0.1UF 50V K B	C314	1	
AT373ZHBAE	BCML811045G	C:CERAMIC M/L (1608) TAPE	0.1UF 50V K B	C315	1	
AT373ZHBAE	BCML811045G	C:CERAMIC M/L (1608) TAPE	0.1UF 50V K B	C317	1	
AT373ZHBAE	BCML811045G	C:CERAMIC M/L (1608) TAPE	0.1UF 50V K B	C318	1	
AT373ZHBAE	BCML811045G	C:CERAMIC M/L (1608) TAPE	0.1UF 50V K B	C319	1	
AT373ZHBAE	BCML811045G	C:CERAMIC M/L (1608) TAPE	0.1UF 50V K B	C327	1	
AT373ZHBAE	BCML811045G	C:CERAMIC M/L (1608) TAPE	0.1UF 50V K B	C337	1	
AT373ZHBAE	BCML811045G	C:CERAMIC M/L (1608) TAPE	0.1UF 50V K B	C341	1	
AT373ZHBAE	BCML811045G	C:CERAMIC M/L (1608) TAPE	0.1UF 50V K B	C356	1	
AT373ZHBAE	BCML811045G	C:CERAMIC M/L (1608) TAPE	0.1UF 50V K B	C360	1	
AT373ZHBAE	BCML811045G	C:CERAMIC M/L (1608) TAPE	0.1UF 50V K B	C362	1	
AT373ZHBAE	BCML811045G	C:CERAMIC M/L (1608) TAPE	0.1UF 50V K B	C405	1	
AT373ZHBAE	BCML811825G	C:CERAMIC M/L (1608) TAPE	0.0018UF 50V K B	C263	1	
AT373ZHBAE	BCML811835G	C:CERAMIC M/L (1608) TAPE	0.018UF 50V K B	C261	1	
AT373ZHBAE	BCML812225G	C:CERAMIC M/L (1608) TAPE	0.0022UF 50V K B	C047	1	
AT373ZHBAE	BCML812225G	C:CERAMIC M/L (1608) TAPE	0.0022UF 50V K B	C052	1	
AT373ZHBAE	BCML812235G	C:CERAMIC M/L (1608) TAPE	0.022UF 50V K B	C109	1	
AT373ZHBAE	BCML812235G	C:CERAMIC M/L (1608) TAPE	0.022UF 50V K B	C258	1	
AT373ZHBAE	BCML812235G	C:CERAMIC M/L (1608) TAPE	0.022UF 50V K B	C262	1	
AT373ZHBAE	BCML812235G	C:CERAMIC M/L (1608) TAPE	0.022UF 50V K B	C304	1	
AT373ZHBAE	BCML812235G	C:CERAMIC M/L (1608) TAPE	0.022UF 50V K B	C306	1	
AT373ZHBAE	BCML814725G	C:CERAMIC M/L (1608) TAPE	0.0047UF 50V K B	C075	1	
AT373ZHBAE	BCML814725G	C:CERAMIC M/L (1608) TAPE	0.0047UF 50V K B	C221	1	
AT373ZHBAE	BCML814725G	C:CERAMIC M/L (1608) TAPE	0.0047UF 50V K B	C227	1	
AT373ZHBAE	BCML814725G	C:CERAMIC M/L (1608) TAPE	0.0047UF 50V K B	C334	1	
AT373ZHBAE	BCML814725G	C:CERAMIC M/L (1608) TAPE	0.0047UF 50V K B	C403	1	
AT373ZHBAE	BCML814725G	C:CERAMIC M/L (1608) TAPE	0.0047UF 50V K B	C404	1	
AT373ZHBAE	BCML814725G	C:CERAMIC M/L (1608) TAPE	0.0047UF 50V K B	C409	1	
AT373ZHBAE	BCML814725G	C:CERAMIC M/L (1608) TAPE	0.0047UF 50V K B	C410	1	
AT373ZHBAE	BCML814735G	C:CERAMIC M/L (1608) TAPE	0.047UF 50V K B	C064	1	
AT373ZHBAE	BCML814735G	C:CERAMIC M/L (1608) TAPE	0.047UF 50V K B	C408	1	

ASSY CODE	PARTS CODE	DESCRIPTION	SPEC	REF NO	QTY	REMARKS
AT373ZHBAE	BCML815635G	C:CERAMIC M/L (1608) TAPE	0.056UF 50V K B	C265	1	
AT373ZHBAE	BCMM811002G	C:CERAMIC M/L (1608) TAPE	10PF 50V D CH	C008	1	
AT373ZHBAE	BCMM811002G	C:CERAMIC M/L (1608) TAPE	10PF 50V D CH	C100	1	
AT373ZHBAE	BCMM811002G	C:CERAMIC M/L (1608) TAPE	10PF 50V D CH	C205	1	
AT373ZHBAE	BCMM811002G	C:CERAMIC M/L (1608) TAPE	10PF 50V D CH	C346	1	
AT373ZHBAE	BCMM811014G	C:CERAMIC M/L (1608) TAPE	100PF 50V J CH	C046	1	
AT373ZHBAE	BCMM811014G	C:CERAMIC M/L (1608) TAPE	100PF 50V J CH	C105	1	
AT373ZHBAE	BCMM811014G	C:CERAMIC M/L (1608) TAPE	100PF 50V J CH	C228	1	
AT373ZHBAE	BCMM811204G	C:CERAMIC M/L (1608) TAPE	12PF 50V J CH	C310	1	
AT373ZHBAE	BCMM811214G	C:CERAMIC M/L (1608) TAPE	120PF 50V J CH	C206	1	
AT373ZHBAE	BCMM811214G	C:CERAMIC M/L (1608) TAPE	120PF 50V J CH	C307	1	
AT373ZHBAE	BCMM811504G	C:CERAMIC M/L (1608) TAPE	15PF 50V J CH	C200	1	
AT373ZHBAE	BCMM811504G	C:CERAMIC M/L (1608) TAPE	15PF 50V J CH	C321	1	
AT373ZHBAE	BCMM811514G	C:CERAMIC M/L (1608) TAPE	150PF 50V J CH	C108	1	
AT373ZHBAE	BCMM811514G	C:CERAMIC M/L (1608) TAPE	150PF 50V J CH	C201	1	
AT373ZHBAE	BCMM811514G	C:CERAMIC M/L (1608) TAPE	150PF 50V J CH	C204	1	
AT373ZHBAE	BCMM811514G	C:CERAMIC M/L (1608) TAPE	150PF 50V J CH	C344	1	
AT373ZHBAE	BCMM811514G	C:CERAMIC M/L (1608) TAPE	150PF 50V J CH	C345	1	
AT373ZHBAE	BCMM811804G	C:CERAMIC M/L (1608) TAPE	18PF 50V J CH	C320	1	
AT373ZHBAE	BCMM811804G	C:CERAMIC M/L (1608) TAPE	18PF 50V J CH	C322	1	
AT373ZHBAE	BCMM811814G	C:CERAMIC M/L (1608) TAPE	180PF 50V J CH	C018	1	
AT373ZHBAE	BCMM811814G	C:CERAMIC M/L (1608) TAPE	180PF 50V J CH	C020	1	
AT373ZHBAE	BCMM812098G	C: CERAMIC M/L (1608) TAPE	2PF 50V B CH	C019	1	
AT373ZHBAE	BCMM812098G	C: CERAMIC M/L (1608) TAPE	2PF 50V B CH	C352	1	
AT373ZHBAE	BCMM812204G	C:CERAMIC M/L (1608) TAPE	22PF 50V J CH	C343	1	
AT373ZHBAE	BCMM812204G	C:CERAMIC M/L (1608) TAPE	22PF 50V J CH	C355	1	
AT373ZHBAE	BCMM812214G	C:CERAMIC M/L (1608) TAPE	220PF 50V J CH	C210	1	
AT373ZHBAE	BCMM812214G	C:CERAMIC M/L (1608) TAPE	220PF 50V J CH	C236	1	
AT373ZHBAE	BCMM812704G	C:CERAMIC M/L (1608) TAPE	27PF 50V J CH	C001	1	
AT373ZHBAE	BCMM812704G	C:CERAMIC M/L (1608) TAPE	27PF 50V J CH	C203	1	
AT373ZHBAE	BCMM812704G	C:CERAMIC M/L (1608) TAPE	27PF 50V J CH	C229	1	
AT373ZHBAE	BCMM812704G	C:CERAMIC M/L (1608) TAPE	27PF 50V J CH	C235	1	
AT373ZHBAE	BCMM812714G	C:CERAMIC M/L (1608) TAPE	270PF 50V J CH	C202	1	
AT373ZHBAE	BCMM812714G	C:CERAMIC M/L (1608) TAPE	270PF 50V J CH	C208	1	
AT373ZHBAE	BCMM813098G	C: CERAMIC M/L (1608) TAPE	3PF 50V B CH	C032	1	
AT373ZHBAE	BCMM813098G	C: CERAMIC M/L (1608) TAPE	3PF 50V B CH	C212	1	
AT373ZHBAE	BCMM813098G	C: CERAMIC M/L (1608) TAPE	3PF 50V B CH	C336	1	
AT373ZHBAE	BCMM813904G	C:CERAMIC M/L (1608) TAPE	39PF 50V J CH	C323	1	
AT373ZHBAE	BCMM813914G	C:CERAMIC M/L (1608) TAPE	390PF 50V J CH	C223	1	
AT373ZHBAE	BCMM814704G	C:CERAMIC M/L (1608) TAPE	47PF 50V J CH	C072	1	
AT373ZHBAE	BCMM814704G	C:CERAMIC M/L (1608) TAPE	47PF 50V J CH	C207	1	
AT373ZHBAE	BCMM814714G	C:CERAMIC M/L (1608) TAPE	470PF 50V J CH	C003	1	
AT373ZHBAE	BCMM814714G	C:CERAMIC M/L (1608) TAPE	470PF 50V J CH	C004	1	
AT373ZHBAE	BCMM815091G	C: CERAMIC M/L (1608) TAPE	5PF 50V C CH	C010	1	
AT373ZHBAE	BCMM815091G	C: CERAMIC M/L (1608) TAPE	5PF 50V C CH	C331	1	

ASSY CODE	PARTS CODE	DESCRIPTION	SPEC	REF NO	QTY	REMARKS
AT373ZHBAE	BCMM815604G	C:CERAMIC M/L (1608) TAPE	56PF 50V J CH	C015	1	
AT373ZHBAE	BCMM815604G	C:CERAMIC M/L (1608) TAPE	56PF 50V J CH	C217	1	
AT373ZHBAE	BCMM815614G	C:CERAMIC M/L (1608) TAPE	560PF 50V J CH	C035	1	
AT373ZHBAE	BCMM818092G	C:CERAMIC M/L (1608) TAPE	8PF 50V D CH	C335	1	
AT373ZHBAE	BCMM818214G	C:CERAMIC M/L (1608) TAPE	820PF 50V J CH	C267	1	
AT373ZHBAE	BCMM819092G	C:CERAMIC M/L (1608) TAPE	9PF 50V D CH	C339	1	
AT373ZHBAE	BCMS815081G	C:CERAMIC M/L (1608) TAPE	0.5PF 50V C CK	C308	1	
AT373ZHBAE	BCSH514786Z	C:TANTALUM CHIP TAPE	0.47UF 25V M C-122 TAPE	C333	1	
AT373ZHBAE	BCSH661086Z	CAPACITOR:TANTALUM CHIP	0.1UF 35V M C-122 TAPE	C332	1	
AT373ZHBAE	BCTG0107500	C:TRIMMER	CT-107 ECRLA050M52 50PF	CT301	1	
AT373ZHBAE	BDAG1220004	DIODE:ZENER	UDZS F 5.1B TE-17	D304	1	
AT373ZHBAE	BDAG1220015	DIODE:ZENER	UDZS F 7.5B TE-17	D202	1	
AT373ZHBAE	BDAG1220015	DIODE:ZENER	UDZS F 7.5B TE-17	D308	1	
AT373ZHBAE	BDAG1220015	DIODE:ZENER	UDZS F 7.5B TE-17	D601	1	
AT373ZHBAE	BDAG1220015	DIODE:ZENER	UDZS F 7.5B TE-17	D602	1	
AT373ZHBAE	BDAG1220015	DIODE:ZENER	UDZS F 7.5B TE-17	D603	1	
AT373ZHBAE	BDAG1220015	DIODE:ZENER	UDZS F 7.5B TE-17	D604	1	
AT373ZHBAE	BDAG1220016	DIODE:ZENER	UDZS F 3.0B TE-17	D206	1	
AT373ZHBAE	BDAG1262001	DIODE:VARICAP	1SV290(TPH3.F)	D305	1	
AT373ZHBAE	BDAG1262001	DIODE:VARICAP	1SV290(TPH3.F)	D306	1	
AT373ZHBAE	BDAG1265001	DIODE	DA-1265 1SS226(TE85L,F)	D311	1	
AT373ZHBAE	BDAG1265001	DIODE	DA-1265 1SS226(TE85L,F)	D401	1	
AT373ZHBAE	BDAG1269001	DIODE	KDS114E-RTK/P	D001	1	
AT373ZHBAE	BDAG1269001	DIODE	KDS114E-RTK/P	D002	1	
AT373ZHBAE	BDAG1270001	DIODE	KDS160E-RTK/P	D301	1	
AT373ZHBAE	BDAG1270001	DIODE	KDS160E-RTK/P	D302	1	
AT373ZHBAE	BDAG1270001	DIODE	KDS160E-RTK/P	D312	1	
AT373ZHBAE	BDAG1270001	DIODE	KDS160E-RTK/P	D402	1	
AT373ZHBAE	BDAG1280001	DIODE:VARICAP	HVU307 TRU-E	D003	1	
AT373ZHBAE	BDAG1280001	DIODE:VARICAP	HVU307 TRU-E	D004	1	
AT373ZHBAE	BDAG1280001	DIODE:VARICAP	HVU307 TRU-E	D009	1	
AT373ZHBAE	BDAG1280001	DIODE:VARICAP	HVU307 TRU-E	D010	1	
AT373ZHBAE	BDAG1280001	DIODE:VARICAP	HVU307 TRU-E	D307	1	
AT373ZHBAE	BDAG1285001	DIODE	HSM88AS TL-E	D101	1	
AT373ZHBAE	BDAG1340002	DIODE:ZENER AX TS 26+	HZ5C1 TD-E	D303	1	
AT373ZHBAE	BDAG1349001	DIODE	GD 1N4003-A2	D203	1	
AT373ZHBAE	BDAG1355001	DIODE	SDB30A40	D309	1	
AT373ZHBAE	BDAG1356003	DIODE	GD 1N4148-GP-A2	D005	1	
AT373ZHBAE	BDAG1356003	DIODE	GD 1N4148-GP-A2	D006	1	
AT373ZHBAE	BDAG1356003	DIODE	GD 1N4148-GP-A2	D008	1	
AT373ZHBAE	BDAG1356003	DIODE	GD 1N4148-GP-A2	D011	1	
AT373ZHBAE	BDAG1356003	DIODE	GD 1N4148-GP-A2	D012	1	
AT373ZHBAE	BDAG1356003	DIODE	GD 1N4148-GP-A2	D013	1	
AT373ZHBAE	BDAG1356003	DIODE	GD 1N4148-GP-A2	D014	1	
AT373ZHBAE	BDAG1356003	DIODE	GD 1N4148-GP-A2	D016	1	

ASSY CODE	PARTS CODE	DESCRIPTION	SPEC	REF NO	QTY	REMARKS
AT373ZHBAE	BDAG1356003	DIODE	GD 1N4148-GP-A2	D022	1	
AT373ZHBAE	BDAG1356003	DIODE	GD 1N4148-GP-A2	D201	1	
AT373ZHBAE	BDAG1356003	DIODE	GD 1N4148-GP-A2	D204	1	
AT373ZHBAE	BDAG1356003	DIODE	GD 1N4148-GP-A2	D205	1	
AT373ZHBAE	BDAG1356003	DIODE	GD 1N4148-GP-A2	D207	1	
AT373ZHBAE	BDAG1356003	DIODE	GD 1N4148-GP-A2	D208	1	
AT373ZHBAE	BDAG1356003	DIODE	GD 1N4148-GP-A2	D310	1	
AT373ZHBAE	BDAG1357001	DIODE:LED	TL5U124(F)	D552	1	
AT373ZHBAE	BDAG1363001	DIODE:LED	VRPG3312X	D553	1	
AT373ZHBAE	BDAY0773001	DIODE:LED	LTD-482PC	D551	1	
AT373ZHBYE	BDBB1135117	TRANSISTOR	DB-147 2SB1135R	Q501	1	
AT373ZHBAE	BDBC2078105	TRANSISTOR	DB-791 2SC2078E	Q200	1	
AT373ZHBAE	BDBC2314106	TRANSISTOR	DB-792 2SC2314F	Q201	1	
AT373ZHBAE	BDBJ1235730	TRANSISTOR	DB-089 2SA1235A-T112-1F	Q104	1	
AT373ZHBAE	BDBJ1235730	TRANSISTOR	DB-089 2SA1235A-T112-1F	Q204	1	
AT373ZHBAE	BDBJ1235730	TRANSISTOR	DB-089 2SA1235A-T112-1F	Q209	1	
AT373ZHBAE	BDBJ1235730	TRANSISTOR	DB-089 2SA1235A-T112-1F	Q213	1	
AT373ZHBAE	BDBJ1235730	TRANSISTOR	DB-089 2SA1235A-T112-1F	Q311	1	
AT373ZHBAE	BDBJ1235730	TRANSISTOR	DB-089 2SA1235A-T112-1F	Q312	1	
AT373ZHBAE	BDBJ1235730	TRANSISTOR	DB-089 2SA1235A-T112-1F	Q551	1	
AT373ZHBAE	BDBJ1235730	TRANSISTOR	DB-089 2SA1235A-T112-1F	Q552	1	
AT373ZHBAE	BDBL0941112	TRANSISTOR	DB-1212 2SC941TM-Y(TPE2,F)	Q202	1	
AT373ZHBAE	BDBL2714124	TRANSISTOR	DB-1167 2SC2714-Y(TE85L,F)	Q001	1	
AT373ZHBAE	BDBL2714124	TRANSISTOR	DB-1167 2SC2714-Y(TE85L,F)	Q004	1	
AT373ZHBAE	BDBL2714124	TRANSISTOR	DB-1167 2SC2714-Y(TE85L,F)	Q005	1	
AT373ZHBAE	BDBL2714124	TRANSISTOR	DB-1167 2SC2714-Y(TE85L,F)	Q012	1	
AT373ZHBAE	BDBL2714124	TRANSISTOR	DB-1167 2SC2714-Y(TE85L,F)	Q101	1	
AT373ZHBAE	BDBL2714124	TRANSISTOR	DB-1167 2SC2714-Y(TE85L,F)	Q102	1	
AT373ZHBAE	BDBL2714124	TRANSISTOR	DB-1167 2SC2714-Y(TE85L,F)	Q105	1	
AT373ZHBAE	BDBL2714124	TRANSISTOR	DB-1167 2SC2714-Y(TE85L,F)	Q203	1	
AT373ZHBAE	BDBL2714124	TRANSISTOR	DB-1167 2SC2714-Y(TE85L,F)	Q302	1	
AT373ZHBAE	BDBL2714124	TRANSISTOR	DB-1167 2SC2714-Y(TE85L,F)	Q305	1	
AT373ZHBAE	BDBL2714124	TRANSISTOR	DB-1167 2SC2714-Y(TE85L,F)	Q306	1	
AT373ZHBAE	BDBL2714124	TRANSISTOR	DB-1167 2SC2714-Y(TE85L,F)	Q308	1	
AT373ZHBAE	BDBL2714124	TRANSISTOR	DB-1167 2SC2714-Y(TE85L,F)	Q310	1	
AT373ZHBAE	BDBL3052730	TRANSISTOR	DB-764 2SC3052-T112-1F	Q006	1	
AT373ZHBAE	BDBL3052730	TRANSISTOR	DB-764 2SC3052-T112-1F	Q007	1	
AT373ZHBAE	BDBL3052730	TRANSISTOR	DB-764 2SC3052-T112-1F	Q008	1	
AT373ZHBAE	BDBL3052730	TRANSISTOR	DB-764 2SC3052-T112-1F	Q010	1	
AT373ZHBAE	BDBL3052730	TRANSISTOR	DB-764 2SC3052-T112-1F	Q013	1	
AT373ZHBAE	BDBL3052730	TRANSISTOR	DB-764 2SC3052-T112-1F	Q014	1	
AT373ZHBAE	BDBL3052730	TRANSISTOR	DB-764 2SC3052-T112-1F	Q015	1	
AT373ZHBAE	BDBL3052730	TRANSISTOR	DB-764 2SC3052-T112-1F	Q016	1	
AT373ZHBAE	BDBL3052730	TRANSISTOR	DB-764 2SC3052-T112-1F	Q017	1	
AT373ZHBAE	BDBL3052730	TRANSISTOR	DB-764 2SC3052-T112-1F	Q103	1	

ASSY CODE	PARTS CODE	DESCRIPTION	SPEC	REF NO	QTY	REMARKS
AT373ZHBAE	BDBL3052730	TRANSISTOR	DB-764 2SC3052-T112-1F	Q205	1	
AT373ZHBAE	BDBL3052730	TRANSISTOR	DB-764 2SC3052-T112-1F	Q210	1	
AT373ZHBAE	BDBL3052730	TRANSISTOR	DB-764 2SC3052-T112-1F	Q211	1	
AT373ZHBAE	BDBL3052730	TRANSISTOR	DB-764 2SC3052-T112-1F	Q214	1	
AT373ZHBAE	BDBL3052730	TRANSISTOR	DB-764 2SC3052-T112-1F	Q301	1	
AT373ZHBAE	BDBL3052730	TRANSISTOR	DB-764 2SC3052-T112-1F	Q309	1	
AT373ZHBAE	BDBL3052730	TRANSISTOR	DB-764 2SC3052-T112-1F	Q313	1	
AT373ZHBAE	BDBL3052730	TRANSISTOR	DB-764 2SC3052-T112-1F	Q401	1	
AT373ZHBAE	BDBL3052730	TRANSISTOR	DB-764 2SC3052-T112-1F	Q402	1	
AT373ZHBAE	BDBL3243105	TRANSISTOR	DB-1211 2SC3243-T111-E	Q212	1	
AT373ZHBAE	BDBL3243105	TRANSISTOR	DB-1211 2SC3243-T111-E	Q307	1	
AT373ZHBAE	BDBL5065124	TRANSISTOR	DB-1169 2SC5065-Y(TE85R,F)	Q304	1	
AT373ZHBAE	BDBM1048732	TRANSISTOR	DB-467 2SD1048-6-TB-E	Q009	1	
AT373ZHBAE	BDBM1048732	TRANSISTOR	DB-467 2SD1048-6-TB-E	Q206	1	
AT373ZHBAE	BDBM1048732	TRANSISTOR	DB-467 2SD1048-6-TB-E	Q303	1	
AT373ZHBAE	BDCCK0210301	FIELD EFFECT TRANSISTOR	DC-310 2SK210-BL(TE85L,F)	Q002	1	
AT373ZHBAE	BDCCK0210301	FIELD EFFECT TRANSISTOR	DC-310 2SK210-BL(TE85L,F)	Q003	1	
AT373ZHBAE	BDDG1590001	INTEGRATED CIRCUIT:UC3042	UPD780022AGC-167-8BS-A	IC300	1	
AT373ZHBAE	BDEG4198003	INTEGRATED CIRCUIT	AT24C02N-10SU-1.8	IC302	1	
AT373ZHBAE	BDEG4222003	INTEGRATED CIRCUIT	TK83361MTL-G	IC002	1	
AT373ZHBAE	BDEG4251003	INTEGRATED CIRCUIT	RH5RL50AA-T1-FA	IC303	1	
AT373ZHBAE	BDEG4404003	INTEGRATED CIRCUIT	XC61CC4302PR	IC304	1	
AT373ZHBAE	BDEG4454003	INTEGRATED CIRCUIT	NJM2746M-TE1-#ZZZB	IC001	1	
AT373ZHBYE	BDEG4462001	INTEGRATED CIRCUIT	E-TDA2003V	IC501	1	
AT373ZHBYE	BDEY0924001	INTEGRATED CIRCUIT	L7808CV	IC503	1	
AT373ZHBAE	BDEY2769003	INTEGRATED CIRCUIT	BU2630F-E2	IC305	1	
AT373ZHBAE	BDEY3654003	INTEGRATED CIRCUIT	NJM12904M-TE3-#ZZZB	IC003	1	
AT373ZHBAE	BDEY3654003	INTEGRATED CIRCUIT	NJM12904M-TE3-#ZZZB	IC201	1	
AT373ZHBAE	BDEY3654003	INTEGRATED CIRCUIT	NJM12904M-TE3-#ZZZB	IC202	1	
AT373ZHBAE	BDEY3654003	INTEGRATED CIRCUIT	NJM12904M-TE3-#ZZZB	IC401	1	
AT373ZHBAE	BFLG1087001	FILTER:CRYSTAL	FL-1087 10M07AZ	FT001	1	
AT373ZHBAE	BFLY0852001	FILTER:CERAMIC	FL-852 LTS455HTW	FT002	1	
AT373ZHBAE	BJKG1249003	JACK	JK-1249 IMSA-9210B-1-03Z058-PT1	J301	1	
AT373ZHBAE	BJKG1310001	JACK:EARPHONE	JK-1310 PJ-305C	J001	1	
AT373ZHBAE	BJKG1310001	JACK:EARPHONE	JK-1310 PJ-305C	J002	1	
AT373ZHBYE	BJKY0052002	JACK	JK-052 BLACK 12T-5C018-S	J503	1	
AT373ZHBYE	BJKY0425002	JACK:W/O LUG	JK-425 M-RM-L 102	J501	1	
AT373ZHBE	BJKY1165001	JACK	JK-1165 PLT-166-RL6	J751	1	
AT373ZHBAE	BLBG1225001	COIL	LB-1225 #7002BE-A0026HM	L011	1	
AT373ZHBAE	BLBG1235001	COIL	LB-1235 KY1106R	L301	1	
AT373ZHBAE	BLBG1235001	COIL	LB-1235 KY1106R	L302	1	
AT373ZHBAE	BLBG1237001	COIL	LB-1237 KS2579N	L003	1	
AT373ZHBAE	BLBG1239001	COIL	LB-1239 KS2585N	L006	1	
AT373ZHBAE	BLBY1120001	COIL	LB-1120 KS2482AC	L007	1	
AT373ZHBAE	BLBY1120001	COIL	LB-1120 KS2482AC	L008	1	

ASSY CODE	PARTS CODE	DESCRIPTION	SPEC	REF NO	QTY	REMARKS
AT373ZHBAE	BLBY1129001	COIL	LB-1129 7PL4A151N	L009	1	
AT373ZHBAE	BLBY1131001	COIL	LB-1131 KS2484F	L001	1	
AT373ZHBAE	BLBY1179001	COIL	LB-1179 7MK4A033N	L010	1	
AT373ZHBAE	BLDY0087001	COIL	LD-087 BF04-3*5*1	L012	1	
AT373ZHBAE	BLDY0087001	COIL	LD-087 BF04-3*5*1	L013	1	
AT373ZHBAE	BLDY0087001	COIL	LD-087 BF04-3*5*1	L014	1	
AT373ZHBAE	BLDY0087001	COIL	LD-087 BF04-3*5*1	L015	1	
AT373ZHBAE	BLDY0087001	COIL	LD-087 BF04-3*5*1	L207	1	
AT373ZHBAE	BLDY0087001	COIL	LD-087 BF04-3*5*1	L209	1	
AT373ZHBAE	BLDY0087001	COIL	LD-087 BF04-3*5*1	L211	1	
AT373ZHBE	BLDY0087001	COIL	LD-087 BF04-3*5*1	L751	1	
AT373ZHBE	BLDY0087001	COIL	LD-087 BF04-3*5*1	L753	1	
AT373ZHBE	BLDY0087001	COIL	LD-087 BF04-3*5*1	L755	1	
AT373ZHBE	BLDY0087001	COIL	LD-087 BF04-3*5*1	L501	1	
AT373ZHBYE	BLDY0252001	COIL	LD-252 3A1737RH	L502	1	
AT373ZHBYE	BLDY0252001	COIL	LD-252 3A1737RH	L201	1	
AT373ZHBAE	BLEY0475001	COIL	LE-475 AC1979	L204	1	
AT373ZHBAE	BLEY0475001	COIL	LE-475 AC1979	L206	1	
AT373ZHBAE	BLEY0475001	COIL	LE-475 AC1979	L202	1	
AT373ZHBAE	BLEY0486001	COIL	LE-486 AC1973	L203	1	
AT373ZHBAE	BLEY0486001	COIL	LE-486 AC1973	L200	1	
AT373ZHBAE	BLEY0492001	COIL	LE-492 AC1926	L205	1	
AT373ZHBAE	BLEY0492001	COIL	LE-492 AC1926	L208	1	
AT373ZHBE	BLZG0041100	INDUCTOR:MOLDED	LZ-041 10UH K	L752	1	
AT373ZHBE	BLZG0041100	INDUCTOR:MOLDED	LZ-041 10UH K	L754	1	
AT373ZHBAE	BLZG0041338	INDUCTOR:MOLDED	LZ-041 0.33UH K	L210	1	
AT373ZHBAE	BLZY0226220	INDUCTOR:MOLDED CHIP	LZ-226 SGM1608N220K T	L101	1	
AT373ZHXYE	BMKG0580001	MICROPHONE	MK-580 EMC503-015	MC951	1	
AT373ZHBYE	BMTY0149001	METER	MT-149	M501	1	
AT373ZHBAE	BPAG0437AAZ	PCB:MAIN	PA-0437AA	B001	1	
AT373ZHBE	BPAG0438AA1	PCB:VOL	PA-438AA 1/6	B801	1	
AT373ZHBE	BPAG0438AA2	PCB:SW	PA-438AA 2/6	B601	1	
AT373ZHBE	BPAG0438AA3	PCB:LED	PA-438AA 3/6	B551	1	
AT373ZHBE	BPAG0438AA4	PCB:MIC	PA-438AA 4/6	B751	1	
AT373ZHBE	BPAG0438AA5	PCB:CH	PA-438AA 5/6	B701	1	
AT373ZHBE	BPAG0438AA6	PCB:RF MIC	PA-438AA 6/6	B651	1	
AT373ZHBAE	BPGG0185001	PLUG	PG-185 IMSA-9215H-T	PG001	1	
AT373ZHBAE	BQXG0848001	CRYSTAL	QX-848 10.240000MHZ	X301	1	
AT373ZHBAE	BQXG0849001	CRYSTAL	QX-849 4.258996MHZ	X302	1	
AT373ZHBAE	BRFC160004G	R:CARBON FIXED CHIP	0 1/16W J TAPE	R004	1	
AT373ZHBAE	BRFC161004G	R:CARBON FIXED CHIP	10 1/16W J TAPE	R051	1	
AT373ZHBAE	BRFC161004G	R:CARBON FIXED CHIP	10 1/16W J TAPE	R205	1	
AT373ZHBAE	BRFC161014G	R:CARBON FIXED CHIP	100 1/16W J TAPE	R025	1	
AT373ZHBAE	BRFC161014G	R:CARBON FIXED CHIP	100 1/16W J TAPE	R037	1	
AT373ZHBAE	BRFC161014G	R:CARBON FIXED CHIP	100 1/16W J TAPE	R048	1	

ASSY CODE	PARTS CODE	DESCRIPTION	SPEC	REF NO	QTY	REMARKS
AT373ZHBAE	BRFC161014G	R:CARBON FIXED CHIP	100 1/16W J TAPE	R085	1	
AT373ZHBAE	BRFC161014G	R:CARBON FIXED CHIP	100 1/16W J TAPE	R086	1	
AT373ZHBAE	BRFC161014G	R:CARBON FIXED CHIP	100 1/16W J TAPE	R118	1	
AT373ZHBAE	BRFC161014G	R:CARBON FIXED CHIP	100 1/16W J TAPE	R230	1	
AT373ZHBAE	BRFC161014G	R:CARBON FIXED CHIP	100 1/16W J TAPE	R282	1	
AT373ZHBAE	BRFC161014G	R:CARBON FIXED CHIP	100 1/16W J TAPE	R332	1	
AT373ZHBAE	BRFC161024G	R:CARBON FIXED CHIP	1K 1/16W J TAPE	R005	1	
AT373ZHBAE	BRFC161024G	R:CARBON FIXED CHIP	1K 1/16W J TAPE	R038	1	
AT373ZHBAE	BRFC161024G	R:CARBON FIXED CHIP	1K 1/16W J TAPE	R042	1	
AT373ZHBAE	BRFC161024G	R:CARBON FIXED CHIP	1K 1/16W J TAPE	R153	1	
AT373ZHBAE	BRFC161024G	R:CARBON FIXED CHIP	1K 1/16W J TAPE	R204	1	
AT373ZHBAE	BRFC161024G	R:CARBON FIXED CHIP	1K 1/16W J TAPE	R220	1	
AT373ZHBAE	BRFC161024G	R:CARBON FIXED CHIP	1K 1/16W J TAPE	R237	1	
AT373ZHBAE	BRFC161024G	R:CARBON FIXED CHIP	1K 1/16W J TAPE	R256	1	
AT373ZHBAE	BRFC161024G	R:CARBON FIXED CHIP	1K 1/16W J TAPE	R262	1	
AT373ZHBAE	BRFC161024G	R:CARBON FIXED CHIP	1K 1/16W J TAPE	R265	1	
AT373ZHBAE	BRFC161024G	R:CARBON FIXED CHIP	1K 1/16W J TAPE	R286	1	
AT373ZHBAE	BRFC161024G	R:CARBON FIXED CHIP	1K 1/16W J TAPE	R290	1	
AT373ZHBAE	BRFC161024G	R:CARBON FIXED CHIP	1K 1/16W J TAPE	R330	1	
AT373ZHBAE	BRFC161024G	R:CARBON FIXED CHIP	1K 1/16W J TAPE	R331	1	
AT373ZHBAE	BRFC161024G	R:CARBON FIXED CHIP	1K 1/16W J TAPE	R336	1	
AT373ZHBAE	BRFC161024G	R:CARBON FIXED CHIP	1K 1/16W J TAPE	R348	1	
AT373ZHBAE	BRFC161024G	R:CARBON FIXED CHIP	1K 1/16W J TAPE	R349	1	
AT373ZHBAE	BRFC161024G	R:CARBON FIXED CHIP	1K 1/16W J TAPE	R350	1	
AT373ZHBAE	BRFC161024G	R:CARBON FIXED CHIP	1K 1/16W J TAPE	R352	1	
AT373ZHBAE	BRFC161024G	R:CARBON FIXED CHIP	1K 1/16W J TAPE	R353	1	
AT373ZHBAE	BRFC161024G	R:CARBON FIXED CHIP	1K 1/16W J TAPE	R363	1	
AT373ZHBAE	BRFC161024G	R:CARBON FIXED CHIP	1K 1/16W J TAPE	R364	1	
AT373ZHBAE	BRFC161024G	R:CARBON FIXED CHIP	1K 1/16W J TAPE	R365	1	
AT373ZHBAE	BRFC161024G	R:CARBON FIXED CHIP	1K 1/16W J TAPE	R366	1	
AT373ZHBAE	BRFC161024G	R:CARBON FIXED CHIP	1K 1/16W J TAPE	R367	1	
AT373ZHBAE	BRFC161024G	R:CARBON FIXED CHIP	1K 1/16W J TAPE	R379	1	
AT373ZHBAE	BRFC161024G	R:CARBON FIXED CHIP	1K 1/16W J TAPE	R380	1	
AT373ZHBAE	BRFC161024G	R:CARBON FIXED CHIP	1K 1/16W J TAPE	R381	1	
AT373ZHBAE	BRFC161024G	R:CARBON FIXED CHIP	1K 1/16W J TAPE	R382	1	
AT373ZHBAE	BRFC161024G	R:CARBON FIXED CHIP	1K 1/16W J TAPE	R384	1	
AT373ZHBAE	BRFC161024G	R:CARBON FIXED CHIP	1K 1/16W J TAPE	R388	1	
AT373ZHBAE	BRFC161024G	R:CARBON FIXED CHIP	1K 1/16W J TAPE	R603	1	
AT373ZHBAE	BRFC161024G	R:CARBON FIXED CHIP	1K 1/16W J TAPE	R604	1	
AT373ZHBAE	BRFC161024G	R:CARBON FIXED CHIP	1K 1/16W J TAPE	R606	1	
AT373ZHBAE	BRFC161024G	R:CARBON FIXED CHIP	1K 1/16W J TAPE	R562	1	
AT373ZHBAE	BRFC161024G	R:CARBON FIXED CHIP	1K 1/16W J TAPE	R565	1	
AT373ZHBAE	BRFC161024G	R:CARBON FIXED CHIP	1K 1/16W J TAPE	R701	1	
AT373ZHBAE	BRFC161024G	R:CARBON FIXED CHIP	1K 1/16W J TAPE	R702	1	
AT373ZHBAE	BRFC161034G	R:CARBON FIXED CHIP	10K 1/16W J TAPE	R001	1	

ASSY CODE	PARTS CODE	DESCRIPTION	SPEC	REF NO	QTY	REMARKS
AT373ZHBAE	BRFC161034G	R:CARBON FIXED CHIP	10K 1/16W J TAPE	R008	1	
AT373ZHBAE	BRFC161034G	R:CARBON FIXED CHIP	10K 1/16W J TAPE	R014	1	
AT373ZHBAE	BRFC161034G	R:CARBON FIXED CHIP	10K 1/16W J TAPE	R017	1	
AT373ZHBAE	BRFC161034G	R:CARBON FIXED CHIP	10K 1/16W J TAPE	R018	1	
AT373ZHBAE	BRFC161034G	R:CARBON FIXED CHIP	10K 1/16W J TAPE	R034	1	
AT373ZHBAE	BRFC161034G	R:CARBON FIXED CHIP	10K 1/16W J TAPE	R054	1	
AT373ZHBAE	BRFC161034G	R:CARBON FIXED CHIP	10K 1/16W J TAPE	R058	1	
AT373ZHBAE	BRFC161034G	R:CARBON FIXED CHIP	10K 1/16W J TAPE	R065	1	
AT373ZHBAE	BRFC161034G	R:CARBON FIXED CHIP	10K 1/16W J TAPE	R069	1	
AT373ZHBAE	BRFC161034G	R:CARBON FIXED CHIP	10K 1/16W J TAPE	R083	1	
AT373ZHBAE	BRFC161034G	R:CARBON FIXED CHIP	10K 1/16W J TAPE	R087	1	
AT373ZHBAE	BRFC161034G	R:CARBON FIXED CHIP	10K 1/16W J TAPE	R088	1	
AT373ZHBAE	BRFC161034G	R:CARBON FIXED CHIP	10K 1/16W J TAPE	R090	1	
AT373ZHBAE	BRFC161034G	R:CARBON FIXED CHIP	10K 1/16W J TAPE	R092	1	
AT373ZHBAE	BRFC161034G	R:CARBON FIXED CHIP	10K 1/16W J TAPE	R112	1	
AT373ZHBAE	BRFC161034G	R:CARBON FIXED CHIP	10K 1/16W J TAPE	R160	1	
AT373ZHBAE	BRFC161034G	R:CARBON FIXED CHIP	10K 1/16W J TAPE	R161	1	
AT373ZHBAE	BRFC161034G	R:CARBON FIXED CHIP	10K 1/16W J TAPE	R201	1	
AT373ZHBAE	BRFC161034G	R:CARBON FIXED CHIP	10K 1/16W J TAPE	R210	1	
AT373ZHBAE	BRFC161034G	R:CARBON FIXED CHIP	10K 1/16W J TAPE	R231	1	
AT373ZHBAE	BRFC161034G	R:CARBON FIXED CHIP	10K 1/16W J TAPE	R240	1	
AT373ZHBAE	BRFC161034G	R:CARBON FIXED CHIP	10K 1/16W J TAPE	R249	1	
AT373ZHBAE	BRFC161034G	R:CARBON FIXED CHIP	10K 1/16W J TAPE	R250	1	
AT373ZHBAE	BRFC161034G	R:CARBON FIXED CHIP	10K 1/16W J TAPE	R268	1	
AT373ZHBAE	BRFC161034G	R:CARBON FIXED CHIP	10K 1/16W J TAPE	R269	1	
AT373ZHBAE	BRFC161034G	R:CARBON FIXED CHIP	10K 1/16W J TAPE	R270	1	
AT373ZHBAE	BRFC161034G	R:CARBON FIXED CHIP	10K 1/16W J TAPE	R274	1	
AT373ZHBAE	BRFC161034G	R:CARBON FIXED CHIP	10K 1/16W J TAPE	R275	1	
AT373ZHBAE	BRFC161034G	R:CARBON FIXED CHIP	10K 1/16W J TAPE	R280	1	
AT373ZHBAE	BRFC161034G	R:CARBON FIXED CHIP	10K 1/16W J TAPE	R284	1	
AT373ZHBAE	BRFC161034G	R:CARBON FIXED CHIP	10K 1/16W J TAPE	R285	1	
AT373ZHBAE	BRFC161034G	R:CARBON FIXED CHIP	10K 1/16W J TAPE	R292	1	
AT373ZHBAE	BRFC161034G	R:CARBON FIXED CHIP	10K 1/16W J TAPE	R302	1	
AT373ZHBAE	BRFC161034G	R:CARBON FIXED CHIP	10K 1/16W J TAPE	R303	1	
AT373ZHBAE	BRFC161034G	R:CARBON FIXED CHIP	10K 1/16W J TAPE	R307	1	
AT373ZHBAE	BRFC161034G	R:CARBON FIXED CHIP	10K 1/16W J TAPE	R319	1	
AT373ZHBAE	BRFC161034G	R:CARBON FIXED CHIP	10K 1/16W J TAPE	R323	1	
AT373ZHBAE	BRFC161034G	R:CARBON FIXED CHIP	10K 1/16W J TAPE	R324	1	
AT373ZHBAE	BRFC161034G	R:CARBON FIXED CHIP	10K 1/16W J TAPE	R327	1	
AT373ZHBAE	BRFC161034G	R:CARBON FIXED CHIP	10K 1/16W J TAPE	R328	1	
AT373ZHBAE	BRFC161034G	R:CARBON FIXED CHIP	10K 1/16W J TAPE	R333	1	
AT373ZHBAE	BRFC161034G	R:CARBON FIXED CHIP	10K 1/16W J TAPE	R334	1	
AT373ZHBAE	BRFC161034G	R:CARBON FIXED CHIP	10K 1/16W J TAPE	R335	1	
AT373ZHBAE	BRFC161034G	R:CARBON FIXED CHIP	10K 1/16W J TAPE	R337	1	
AT373ZHBAE	BRFC161034G	R:CARBON FIXED CHIP	10K 1/16W J TAPE	R338	1	

ASSY CODE	PARTS CODE	DESCRIPTION	SPEC	REF NO	QTY	REMARKS
AT373ZHBAE	BRFC161034G	R:CARBON FIXED CHIP	10K 1/16W J TAPE	R339	1	
AT373ZHBAE	BRFC161034G	R:CARBON FIXED CHIP	10K 1/16W J TAPE	R351	1	
AT373ZHBAE	BRFC161034G	R:CARBON FIXED CHIP	10K 1/16W J TAPE	R355	1	
AT373ZHBAE	BRFC161034G	R:CARBON FIXED CHIP	10K 1/16W J TAPE	R356	1	
AT373ZHBAE	BRFC161034G	R:CARBON FIXED CHIP	10K 1/16W J TAPE	R357	1	
AT373ZHBAE	BRFC161034G	R:CARBON FIXED CHIP	10K 1/16W J TAPE	R361	1	
AT373ZHBAE	BRFC161034G	R:CARBON FIXED CHIP	10K 1/16W J TAPE	R371	1	
AT373ZHBAE	BRFC161034G	R:CARBON FIXED CHIP	10K 1/16W J TAPE	R373	1	
AT373ZHBAE	BRFC161034G	R:CARBON FIXED CHIP	10K 1/16W J TAPE	R383	1	
AT373ZHBAE	BRFC161034G	R:CARBON FIXED CHIP	10K 1/16W J TAPE	R398	1	
AT373ZHBAE	BRFC161034G	R:CARBON FIXED CHIP	10K 1/16W J TAPE	R399	1	
AT373ZHBAE	BRFC161034G	R:CARBON FIXED CHIP	10K 1/16W J TAPE	R405	1	
AT373ZHBAE	BRFC161034G	R:CARBON FIXED CHIP	10K 1/16W J TAPE	R410	1	
AT373ZHBAE	BRFC161034G	R:CARBON FIXED CHIP	10K 1/16W J TAPE	R411	1	
AT373ZHBAE	BRFC161034G	R:CARBON FIXED CHIP	10K 1/16W J TAPE	R414	1	
AT373ZHBAE	BRFC161034G	R:CARBON FIXED CHIP	10K 1/16W J TAPE	R601	1	
AT373ZHBAE	BRFC161034G	R:CARBON FIXED CHIP	10K 1/16W J TAPE	R561	1	
AT373ZHBAE	BRFC161034G	R:CARBON FIXED CHIP	10K 1/16W J TAPE	R563	1	
AT373ZHBAE	BRFC161034G	R:CARBON FIXED CHIP	10K 1/16W J TAPE	R564	1	
AT373ZHBAE	BRFC161044G	R:CARBON FIXED CHIP	100K 1/16W J TAPE	R012	1	
AT373ZHBAE	BRFC161044G	R:CARBON FIXED CHIP	100K 1/16W J TAPE	R013	1	
AT373ZHBAE	BRFC161044G	R:CARBON FIXED CHIP	100K 1/16W J TAPE	R059	1	
AT373ZHBAE	BRFC161044G	R:CARBON FIXED CHIP	100K 1/16W J TAPE	R061	1	
AT373ZHBAE	BRFC161044G	R:CARBON FIXED CHIP	100K 1/16W J TAPE	R094	1	
AT373ZHBAE	BRFC161044G	R:CARBON FIXED CHIP	100K 1/16W J TAPE	R097	1	
AT373ZHBAE	BRFC161044G	R:CARBON FIXED CHIP	100K 1/16W J TAPE	R163	1	
AT373ZHBAE	BRFC161044G	R:CARBON FIXED CHIP	100K 1/16W J TAPE	R202	1	
AT373ZHBAE	BRFC161044G	R:CARBON FIXED CHIP	100K 1/16W J TAPE	R345	1	
AT373ZHBAE	BRFC161044G	R:CARBON FIXED CHIP	100K 1/16W J TAPE	R602	1	
AT373ZHBAE	BRFC161054G	R:CARBON FIXED CHIP	1M 1/16W J TAPE	R057	1	
AT373ZHBAE	BRFC161054G	R:CARBON FIXED CHIP	1M 1/16W J TAPE	R067	1	
AT373ZHBAE	BRFC161054G	R:CARBON FIXED CHIP	1M 1/16W J TAPE	R098	1	
AT373ZHBAE	BRFC161054G	R:CARBON FIXED CHIP	1M 1/16W J TAPE	R158	1	
AT373ZHBAE	BRFC161054G	R:CARBON FIXED CHIP	1M 1/16W J TAPE	R347	1	
AT373ZHBAE	BRFC161054G	R:CARBON FIXED CHIP	1M 1/16W J TAPE	R358	1	
AT373ZHBAE	BRFC161054G	R:CARBON FIXED CHIP	1M 1/16W J TAPE	R378	1	
AT373ZHBAE	BRFC161234G	R:CARBON FIXED CHIP	12K 1/16W J TAPE	R311	1	
AT373ZHBAE	BRFC161504G	R:CARBON FIXED CHIP	15 1/16W J TAPE	R209	1	
AT373ZHBAE	BRFC161514G	R:CARBON FIXED CHIP	150 1/16W J TAPE	R044	1	
AT373ZHBAE	BRFC161514G	R:CARBON FIXED CHIP	150 1/16W J TAPE	R052	1	
AT373ZHBAE	BRFC161514G	R:CARBON FIXED CHIP	150 1/16W J TAPE	R272	1	
AT373ZHBAE	BRFC161524G	R:CARBON FIXED CHIP	1.5K 1/16W J TAPE	R100	1	
AT373ZHBAE	BRFC161524G	R:CARBON FIXED CHIP	1.5K 1/16W J TAPE	R120	1	
AT373ZHBAE	BRFC161524G	R:CARBON FIXED CHIP	1.5K 1/16W J TAPE	R234	1	
AT373ZHBAE	BRFC161524G	R:CARBON FIXED CHIP	1.5K 1/16W J TAPE	R277	1	

ASSY CODE	PARTS CODE	DESCRIPTION	SPEC	REF NO	QTY	REMARKS
AT373ZHBAE	BRFC161524G	R:CARBON FIXED CHIP	1.5K 1/16W J TAPE	R294	1	
AT373ZHBAE	BRFC161524G	R:CARBON FIXED CHIP	1.5K 1/16W J TAPE	R317	1	
AT373ZHBAE	BRFC161534G	R:CARBON FIXED CHIP	15K 1/16W J TAPE	R028	1	
AT373ZHBAE	BRFC161534G	R:CARBON FIXED CHIP	15K 1/16W J TAPE	R040	1	
AT373ZHBAE	BRFC161534G	R:CARBON FIXED CHIP	15K 1/16W J TAPE	R091	1	
AT373ZHBAE	BRFC161534G	R:CARBON FIXED CHIP	15K 1/16W J TAPE	R150	1	
AT373ZHBAE	BRFC161544G	R:CARBON FIXED CHIP	150K 1/16W J TAPE	R056	1	
AT373ZHBAE	BRFC161544G	R:CARBON FIXED CHIP	150K 1/16W J TAPE	R159	1	
AT373ZHBAE	BRFC161554G	R:CARBON FIXED CHIP	1.5M 1/16W J TAPE	R099	1	
AT373ZHBAE	BRFC161814G	R:CARBON FIXED CHIP	180 1/16W J TAPE	R154	1	
AT373ZHBAE	BRFC161824G	R:CARBON FIXED CHIP	1.8K 1/16W J TAPE	R032	1	
AT373ZHBAE	BRFC161824G	R:CARBON FIXED CHIP	1.8K 1/16W J TAPE	R214	1	
AT373ZHBAE	BRFC162204G	R:CARBON FIXED CHIP	22 1/16W J TAPE	R020	1	
AT373ZHBAE	BRFC162214G	R:CARBON FIXED CHIP	220 1/16W J TAPE	R015	1	
AT373ZHBAE	BRFC162214G	R:CARBON FIXED CHIP	220 1/16W J TAPE	R029	1	
AT373ZHBAE	BRFC162214G	R:CARBON FIXED CHIP	220 1/16W J TAPE	R030	1	
AT373ZHBAE	BRFC162214G	R:CARBON FIXED CHIP	220 1/16W J TAPE	R035	1	
AT373ZHBAE	BRFC162214G	R:CARBON FIXED CHIP	220 1/16W J TAPE	R073	1	
AT373ZHBAE	BRFC162214G	R:CARBON FIXED CHIP	220 1/16W J TAPE	R216	1	
AT373ZHBAE	BRFC162214G	R:CARBON FIXED CHIP	220 1/16W J TAPE	R219	1	
AT373ZHBAE	BRFC162214G	R:CARBON FIXED CHIP	220 1/16W J TAPE	R244	1	
AT373ZHBAE	BRFC162214G	R:CARBON FIXED CHIP	220 1/16W J TAPE	R299	1	
AT373ZHBAE	BRFC162214G	R:CARBON FIXED CHIP	220 1/16W J TAPE	R391	1	
AT373ZHBBE	BRFC162214G	R:CARBON FIXED CHIP	220 1/16W J TAPE	R801	1	
AT373ZHBAE	BRFC162224G	R:CARBON FIXED CHIP	2.2K 1/16W J TAPE	R006	1	
AT373ZHBAE	BRFC162224G	R:CARBON FIXED CHIP	2.2K 1/16W J TAPE	R039	1	
AT373ZHBAE	BRFC162224G	R:CARBON FIXED CHIP	2.2K 1/16W J TAPE	R046	1	
AT373ZHBAE	BRFC162224G	R:CARBON FIXED CHIP	2.2K 1/16W J TAPE	R050	1	
AT373ZHBAE	BRFC162224G	R:CARBON FIXED CHIP	2.2K 1/16W J TAPE	R257	1	
AT373ZHBAE	BRFC162224G	R:CARBON FIXED CHIP	2.2K 1/16W J TAPE	R260	1	
AT373ZHBAE	BRFC162224G	R:CARBON FIXED CHIP	2.2K 1/16W J TAPE	R267	1	
AT373ZHBAE	BRFC162224G	R:CARBON FIXED CHIP	2.2K 1/16W J TAPE	R273	1	
AT373ZHBAE	BRFC162224G	R:CARBON FIXED CHIP	2.2K 1/16W J TAPE	R276	1	
AT373ZHBAE	BRFC162224G	R:CARBON FIXED CHIP	2.2K 1/16W J TAPE	R287	1	
AT373ZHBAE	BRFC162224G	R:CARBON FIXED CHIP	2.2K 1/16W J TAPE	R316	1	
AT373ZHBAE	BRFC162224G	R:CARBON FIXED CHIP	2.2K 1/16W J TAPE	R408	1	
AT373ZHBAE	BRFC162234G	R:CARBON FIXED CHIP	22K 1/16W J TAPE	R080	1	
AT373ZHBAE	BRFC162234G	R:CARBON FIXED CHIP	22K 1/16W J TAPE	R217	1	
AT373ZHBAE	BRFC162234G	R:CARBON FIXED CHIP	22K 1/16W J TAPE	R301	1	
AT373ZHBAE	BRFC162234G	R:CARBON FIXED CHIP	22K 1/16W J TAPE	R390	1	
AT373ZHBAE	BRFC162244G	R:CARBON FIXED CHIP	220K 1/16W J TAPE	R064	1	
AT373ZHBAE	BRFC162244G	R:CARBON FIXED CHIP	220K 1/16W J TAPE	R261	1	
AT373ZHBAE	BRFC162244G	R:CARBON FIXED CHIP	220K 1/16W J TAPE	R401	1	
AT373ZHBAE	BRFC162254G	R:CARBON FIXED CHIP	2.2M 1/16W J TAPE	R359	1	
AT373ZHBAE	BRFC162294G	R:CARBON FIXED CHIP	2.2 1/16W J TAPE	R117	1	

ASSY CODE	PARTS CODE	DESCRIPTION	SPEC	REF NO	QTY	REMARKS
AT373ZHBAE	BRFC162714G	R:CARBON FIXED CHIP	270 1/16W J TAPE	R022	1	
AT373ZHBAE	BRFC162714G	R:CARBON FIXED CHIP	270 1/16W J TAPE	R024	1	
AT373ZHBAE	BRFC162714G	R:CARBON FIXED CHIP	270 1/16W J TAPE	R211	1	
AT373ZHBAE	BRFC162714G	R:CARBON FIXED CHIP	270 1/16W J TAPE	R254	1	
AT373ZHBAE	BRFC162714G	R:CARBON FIXED CHIP	270 1/16W J TAPE	R255	1	
AT373ZHBAE	BRFC162714G	R:CARBON FIXED CHIP	270 1/16W J TAPE	R389	1	
AT373ZHBAE	BRFC162714G	R:CARBON FIXED CHIP	270 1/16W J TAPE	R551	1	
AT373ZHBAE	BRFC162714G	R:CARBON FIXED CHIP	270 1/16W J TAPE	R552	1	
AT373ZHBAE	BRFC162714G	R:CARBON FIXED CHIP	270 1/16W J TAPE	R553	1	
AT373ZHBAE	BRFC162714G	R:CARBON FIXED CHIP	270 1/16W J TAPE	R554	1	
AT373ZHBAE	BRFC162714G	R:CARBON FIXED CHIP	270 1/16W J TAPE	R555	1	
AT373ZHBAE	BRFC162714G	R:CARBON FIXED CHIP	270 1/16W J TAPE	R556	1	
AT373ZHBAE	BRFC162714G	R:CARBON FIXED CHIP	270 1/16W J TAPE	R557	1	
AT373ZHBAE	BRFC162724G	R:CARBON FIXED CHIP	2.7K 1/16W J TAPE	R101	1	
AT373ZHBAE	BRFC162724G	R:CARBON FIXED CHIP	2.7K 1/16W J TAPE	R402	1	
AT373ZHBAE	BRFC162734G	R:CARBON FIXED CHIP	27K 1/16W J TAPE	R314	1	
AT373ZHBAE	BRFC162744G	R:CARBON FIXED CHIP	270K 1/16W J TAPE	R110	1	
AT373ZHBAE	BRFC163304G	R:CARBON FIXED CHIP	33 1/16W J TAPE	R208	1	
AT373ZHBAE	BRFC163314G	R:CARBON FIXED CHIP	330 1/16W J TAPE	R221	1	
AT373ZHBAE	BRFC163314G	R:CARBON FIXED CHIP	330 1/16W J TAPE	R281	1	
AT373ZHBAE	BRFC163324G	R:CARBON FIXED CHIP	3.3K 1/16W J TAPE	R066	1	
AT373ZHBAE	BRFC163324G	R:CARBON FIXED CHIP	3.3K 1/16W J TAPE	R081	1	
AT373ZHBAE	BRFC163324G	R:CARBON FIXED CHIP	3.3K 1/16W J TAPE	R104	1	
AT373ZHBAE	BRFC163324G	R:CARBON FIXED CHIP	3.3K 1/16W J TAPE	R105	1	
AT373ZHBAE	BRFC163324G	R:CARBON FIXED CHIP	3.3K 1/16W J TAPE	R152	1	
AT373ZHBAE	BRFC163324G	R:CARBON FIXED CHIP	3.3K 1/16W J TAPE	R215	1	
AT373ZHBAE	BRFC163324G	R:CARBON FIXED CHIP	3.3K 1/16W J TAPE	R238	1	
AT373ZHBAE	BRFC163324G	R:CARBON FIXED CHIP	3.3K 1/16W J TAPE	R253	1	
AT373ZHBAE	BRFC163324G	R:CARBON FIXED CHIP	3.3K 1/16W J TAPE	R288	1	
AT373ZHBAE	BRFC163324G	R:CARBON FIXED CHIP	3.3K 1/16W J TAPE	R304	1	
AT373ZHBAE	BRFC163324G	R:CARBON FIXED CHIP	3.3K 1/16W J TAPE	R310	1	
AT373ZHBAE	BRFC163324G	R:CARBON FIXED CHIP	3.3K 1/16W J TAPE	R318	1	
AT373ZHBAE	BRFC163324G	R:CARBON FIXED CHIP	3.3K 1/16W J TAPE	R322	1	
AT373ZHBAE	BRFC163324G	R:CARBON FIXED CHIP	3.3K 1/16W J TAPE	R325	1	
AT373ZHBAE	BRFC163324G	R:CARBON FIXED CHIP	3.3K 1/16W J TAPE	R326	1	
AT373ZHBAE	BRFC163324G	R:CARBON FIXED CHIP	3.3K 1/16W J TAPE	R354	1	
AT373ZHBAE	BRFC163324G	R:CARBON FIXED CHIP	3.3K 1/16W J TAPE	R368	1	
AT373ZHBAE	BRFC163324G	R:CARBON FIXED CHIP	3.3K 1/16W J TAPE	R369	1	
AT373ZHBAE	BRFC163324G	R:CARBON FIXED CHIP	3.3K 1/16W J TAPE	R370	1	
AT373ZHBAE	BRFC163324G	R:CARBON FIXED CHIP	3.3K 1/16W J TAPE	R372	1	
AT373ZHBAE	BRFC163324G	R:CARBON FIXED CHIP	3.3K 1/16W J TAPE	R385	1	
AT373ZHBAE	BRFC163334G	R:CARBON FIXED CHIP	33K 1/16W J TAPE	R082	1	
AT373ZHBAE	BRFC163334G	R:CARBON FIXED CHIP	33K 1/16W J TAPE	R115	1	
AT373ZHBAE	BRFC163334G	R:CARBON FIXED CHIP	33K 1/16W J TAPE	R247	1	
AT373ZHBAE	BRFC163334G	R:CARBON FIXED CHIP	33K 1/16W J TAPE	R248	1	

ASSY CODE	PARTS CODE	DESCRIPTION	SPEC	REF NO	QTY	REMARKS
AT373ZHBAE	BRFC163334G	R:CARBON FIXED CHIP	33K 1/16W J TAPE	R258	1	
AT373ZHBAE	BRFC163334G	R:CARBON FIXED CHIP	33K 1/16W J TAPE	R259	1	
AT373ZHBAE	BRFC163394G	R:CARBON FIXED CHIP	3.3 1/16W J TAPE	R045	1	
AT373ZHBAE	BRFC163394G	R:CARBON FIXED CHIP	3.3 1/16W J TAPE	R206	1	
AT373ZHBAE	BRFC163914G	R:CARBON FIXED CHIP	390 1/16W J TAPE	R023	1	
AT373ZHBAE	BRFC163914G	R:CARBON FIXED CHIP	390 1/16W J TAPE	R392	1	
AT373ZHBAE	BRFC163914G	R:CARBON FIXED CHIP	390 1/16W J TAPE	R404	1	
AT373ZHBAE	BRFC163914G	R:CARBON FIXED CHIP	390 1/16W J TAPE	R409	1	
AT373ZHBAE	BRFC163924G	R:CARBON FIXED CHIP	3.9K 1/16W J TAPE	R079	1	
AT373ZHBAE	BRFC163934G	R:CARBON FIXED CHIP	39K 1/16W J TAPE	R235	1	
AT373ZHBAE	BRFC163934G	R:CARBON FIXED CHIP	39K 1/16W J TAPE	R266	1	
AT373ZHBAE	BRFC163934G	R:CARBON FIXED CHIP	39K 1/16W J TAPE	R313	1	
AT373ZHBAE	BRFC164704G	R:CARBON FIXED CHIP	47 1/16W J TAPE	R003	1	
AT373ZHBAE	BRFC164704G	R:CARBON FIXED CHIP	47 1/16W J TAPE	R053	1	
AT373ZHBAE	BRFC164704G	R:CARBON FIXED CHIP	47 1/16W J TAPE	R116	1	
AT373ZHBAE	BRFC164714G	R:CARBON FIXED CHIP	470 1/16W J TAPE	R395	1	
AT373ZHBAE	BRFC164714G	R:CARBON FIXED CHIP	470 1/16W J TAPE	R560	1	
AT373ZHBAE	BRFC164724G	R:CARBON FIXED CHIP	4.7K 1/16W J TAPE	R070	1	
AT373ZHBAE	BRFC164724G	R:CARBON FIXED CHIP	4.7K 1/16W J TAPE	R232	1	
AT373ZHBAE	BRFC164724G	R:CARBON FIXED CHIP	4.7K 1/16W J TAPE	R236	1	
AT373ZHBAE	BRFC164724G	R:CARBON FIXED CHIP	4.7K 1/16W J TAPE	R321	1	
AT373ZHBAE	BRFC164734G	R:CARBON FIXED CHIP	47K 1/16W J TAPE	R049	1	
AT373ZHBAE	BRFC164734G	R:CARBON FIXED CHIP	47K 1/16W J TAPE	R093	1	
AT373ZHBAE	BRFC164734G	R:CARBON FIXED CHIP	47K 1/16W J TAPE	R151	1	
AT373ZHBAE	BRFC164734G	R:CARBON FIXED CHIP	47K 1/16W J TAPE	R162	1	
AT373ZHBAE	BRFC164734G	R:CARBON FIXED CHIP	47K 1/16W J TAPE	R283	1	
AT373ZHBAE	BRFC164734G	R:CARBON FIXED CHIP	47K 1/16W J TAPE	R289	1	
AT373ZHBAE	BRFC164734G	R:CARBON FIXED CHIP	47K 1/16W J TAPE	R298	1	
AT373ZHBAE	BRFC164734G	R:CARBON FIXED CHIP	47K 1/16W J TAPE	R306	1	
AT373ZHBAE	BRFC164734G	R:CARBON FIXED CHIP	47K 1/16W J TAPE	R320	1	
AT373ZHBAE	BRFC164734G	R:CARBON FIXED CHIP	47K 1/16W J TAPE	R375	1	
AT373ZHBAE	BRFC164734G	R:CARBON FIXED CHIP	47K 1/16W J TAPE	R376	1	
AT373ZHBAE	BRFC164734G	R:CARBON FIXED CHIP	47K 1/16W J TAPE	R393	1	
AT373ZHBAE	BRFC164734G	R:CARBON FIXED CHIP	47K 1/16W J TAPE	R394	1	
AT373ZHBAE	BRFC164734G	R:CARBON FIXED CHIP	47K 1/16W J TAPE	R397	1	
AT373ZHBAE	BRFC164744G	R:CARBON FIXED CHIP	470K 1/16W J TAPE	R068	1	
AT373ZHBAE	BRFC165604G	R:CARBON FIXED CHIP	56 1/16W J TAPE	R072	1	
AT373ZHBAE	BRFC165604G	R:CARBON FIXED CHIP	56 1/16W J TAPE	R213	1	
AT373ZHBAE	BRFC165604G	R:CARBON FIXED CHIP	56 1/16W J TAPE	R218	1	
AT373ZHBAE	BRFC165614G	R:CARBON FIXED CHIP	560 1/16W J TAPE	R007	1	
AT373ZHBAE	BRFC165614G	R:CARBON FIXED CHIP	560 1/16W J TAPE	R009	1	
AT373ZHBAE	BRFC165614G	R:CARBON FIXED CHIP	560 1/16W J TAPE	R033	1	
AT373ZHBAE	BRFC165614G	R:CARBON FIXED CHIP	560 1/16W J TAPE	R041	1	
AT373ZHBAE	BRFC165614G	R:CARBON FIXED CHIP	560 1/16W J TAPE	R047	1	
AT373ZHBAE	BRFC165614G	R:CARBON FIXED CHIP	560 1/16W J TAPE	R096	1	

ASSY CODE	PARTS CODE	DESCRIPTION	SPEC	REF NO	QTY	REMARKS
AT373ZHBAE	BRFC165614G	R:CARBON FIXED CHIP	560 1/16W J TAPE	R271	1	
AT373ZHBAE	BRFC165614G	R:CARBON FIXED CHIP	560 1/16W J TAPE	R374	1	
AT373ZHBAE	BRFC165614G	R:CARBON FIXED CHIP	560 1/16W J TAPE	R559	1	
AT373ZHBAE	BRFC165624G	R:CARBON FIXED CHIP	5.6K 1/16W J TAPE	R071	1	
AT373ZHBAE	BRFC165624G	R:CARBON FIXED CHIP	5.6K 1/16W J TAPE	R075	1	
AT373ZHBAE	BRFC165624G	R:CARBON FIXED CHIP	5.6K 1/16W J TAPE	R103	1	
AT373ZHBAE	BRFC165624G	R:CARBON FIXED CHIP	5.6K 1/16W J TAPE	R111	1	
AT373ZHBAE	BRFC165624G	R:CARBON FIXED CHIP	5.6K 1/16W J TAPE	R113	1	
AT373ZHBAE	BRFC165624G	R:CARBON FIXED CHIP	5.6K 1/16W J TAPE	R203	1	
AT373ZHBAE	BRFC165624G	R:CARBON FIXED CHIP	5.6K 1/16W J TAPE	R233	1	
AT373ZHBAE	BRFC165624G	R:CARBON FIXED CHIP	5.6K 1/16W J TAPE	R245	1	
AT373ZHBAE	BRFC165624G	R:CARBON FIXED CHIP	5.6K 1/16W J TAPE	R278	1	
AT373ZHBAE	BRFC165624G	R:CARBON FIXED CHIP	5.6K 1/16W J TAPE	R293	1	
AT373ZHBAE	BRFC165624G	R:CARBON FIXED CHIP	5.6K 1/16W J TAPE	R386	1	
AT373ZHBAE	BRFC165624G	R:CARBON FIXED CHIP	5.6K 1/16W J TAPE	R403	1	
AT373ZHBAE	BRFC165634G	R:CARBON FIXED CHIP	56K 1/16W J TAPE	R027	1	
AT373ZHBAE	BRFC165634G	R:CARBON FIXED CHIP	56K 1/16W J TAPE	R062	1	
AT373ZHBAE	BRFC165634G	R:CARBON FIXED CHIP	56K 1/16W J TAPE	R264	1	
AT373ZHBAE	BRFC165634G	R:CARBON FIXED CHIP	56K 1/16W J TAPE	R377	1	
AT373ZHBAE	BRFC165634G	R:CARBON FIXED CHIP	56K 1/16W J TAPE	R407	1	
AT373ZHBAE	BRFC165644G	R:CARBON FIXED CHIP	560K 1/16W J TAPE	R412	1	
AT373ZHBAE	BRFC166814G	R:CARBON FIXED CHIP	680 1/16W J TAPE	R031	1	
AT373ZHBAE	BRFC166824G	R:CARBON FIXED CHIP	6.8K 1/16W J TAPE	R026	1	
AT373ZHBAE	BRFC166824G	R:CARBON FIXED CHIP	6.8K 1/16W J TAPE	R119	1	
AT373ZHBAE	BRFC166824G	R:CARBON FIXED CHIP	6.8K 1/16W J TAPE	R558	1	
AT373ZHBAE	BRFC166834G	R:CARBON FIXED CHIP	68K 1/16W J TAPE	R019	1	
AT373ZHBAE	BRFC166834G	R:CARBON FIXED CHIP	68K 1/16W J TAPE	R060	1	
AT373ZHBAE	BRFC166834G	R:CARBON FIXED CHIP	68K 1/16W J TAPE	R312	1	
AT373ZHBAE	BRFC166834G	R:CARBON FIXED CHIP	68K 1/16W J TAPE	R406	1	
AT373ZHBAE	BRFC166834G	R:CARBON FIXED CHIP	68K 1/16W J TAPE	R413	1	
AT373ZHBAE	BRFC166844G	R:CARBON FIXED CHIP	680K 1/16W J TAPE	R063	1	
AT373ZHBAE	BRFC168224G	R:CARBON FIXED CHIP	8.2K 1/16W J TAPE	R102	1	
AT373ZHBAE	BRFC168224G	R:CARBON FIXED CHIP	8.2K 1/16W J TAPE	R315	1	
AT373ZHBAE	BRFC182204G	R:CARBON FIXED CHIP	22 1/8W J TAPE	R300	1	
AT373ZHBAE	BRFC182204G	R:CARBON FIXED CHIP	22 1/8W J TAPE	R400	1	
AT373ZHBAE	BRFC184714G	R:CARBON FIXED CHIP	470 1/8W J TAPE	R309	1	
AT373ZHBAE	BRFC185614G	R:CARBON FIXED CHIP	560 1/8W J TAPE	R305	1	
AT373ZHBAE	BRFC188204G	R:CARBON FIXED CHIP	82 1/8W J TAPE	R396	1	
AT373ZHBAE	BRFT141034Z	R:CARBON AXIAL LEAD (52)	10K 1/4W J TAPE	R387	1	
AT373ZHBAE	BRFT141044Z	R:CARBON AXIAL LEAD (52)	100K 1/4W J TAPE	R084	1	
AT373ZHBAE	BRFT141044Z	R:CARBON AXIAL LEAD (52)	100K 1/4W J TAPE	R095	1	
AT373ZHBAE	BRPA611034Z	R:CARBON AXIAL LEAD (26)	10K 1/6W J TAPE	R340	1	
AT373ZHBAE	BRPA611034Z	R:CARBON AXIAL LEAD (26)	10K 1/6W J TAPE	R341	1	
AT373ZHBAE	BRPA611034Z	R:CARBON AXIAL LEAD (26)	10K 1/6W J TAPE	R342	1	
AT373ZHBAE	BRPA611034Z	R:CARBON AXIAL LEAD (26)	10K 1/6W J TAPE	R343	1	

ASSY CODE	PARTS CODE	DESCRIPTION	SPEC	REF NO	QTY	REMARKS
AT373ZHBAE	BRPA611044Z	R:CARBON AXIAL LEAD (26)	100K 1/6W J TAPE	R002	1	
AT373ZHBAE	BRSJ001014Z	R:METAL OXIDE	100 1WS J	R295	1	
AT373ZHBAE	BRSJ002214Z	R:METAL OXIDE	220 1WS J	R212	1	
AT373ZHBAE	BRSJ005604Z	RESISTOR:METAL OXIDE	56 1WS J	R308	1	
AT373ZHBAE	BRSJ008204Z	R:METAL OXIDE	82 1WS J	R296	1	
AT373ZHBAE	BRSJ034794Z	RESISTOR:METAL OXIDE	4.7 3WS J	R130	1	
AT373ZHBAE	BRTG0582102	R:SEMI-FIXED	RT-582 PVZ3A102E01R00	RT202	1	
AT373ZHBAE	BRTG0582102	R:SEMI-FIXED	RT-582 PVZ3A102E01R00	RT206	1	
AT373ZHBAE	BRTG0582102	R:SEMI-FIXED	RT-582 PVZ3A102E01R00	RT401	1	
AT373ZHBAE	BRTG0582103	R:SEMI-FIXED	RT-582 PVZ3A103E01R00	RT201	1	
AT373ZHBAE	BRTG0582222	R:SEMI-FIXED	RT-582 PVZ3A222E01R00	RT203	1	
AT373ZHBAE	BRTG0582472	R:SEMI-FIXED	RT-582 PVZ3A472E01R00	RT001	1	
AT373ZHBAE	BRTG0582472	R:SEMI-FIXED	RT-582 PVZ3A472E01R00	RT002	1	
AT373ZHBAE	BRTG0582472	R:SEMI-FIXED	RT-582 PVZ3A472E01R00	RT204	1	
AT373ZHBAE	BRTG0582472	R:SEMI-FIXED	RT-582 PVZ3A472E01R00	RT205	1	
AT373ZHBBE	BRVG0959001	R:VARIABLE	RV-959 B16A53F21	VR801	1	
AT373ZHBBE	BRVG0960001	R:VARIABLE	RV-960 B16B52F21	VR802	1	
AT373ZHBBE	BRVG0966001	R:VARIABLE	RV-966 5KB/5KA	VR651	1	
AT373ZHBYE	BSPG0475001	SPEAKER	SP-475 YD77A-70F16	SP501	1	
AT373ZHBFE	BSRG0463001	SWITCH:ROTARY	SR-463 SR10030F-40F-F7-008	S701	1	
AT373ZHBCB	BSMY0763001	SWITCH:SLIDE	SW-763 SMDPL22-15K	S602	1	
AT373ZHBCB	BSMY0763001	SWITCH:SLIDE	SW-763 SMDPL22-15K	S603	1	
AT373ZHBCB	BSMY0763001	SWITCH:SLIDE	SW-763 SMDPL22-15K	S604	1	
AT373ZHBCB	BSMY0763001	SWITCH:SLIDE	SW-763 SMDPL22-15K	S605	1	
AT373ZHBCB	BSMY0764001	SWITCH:SLIDE	SW-764 SMEP23-15K	S601	1	
AT373ZHBAE	BTFY0157001	TRANSFORMER:AF CHOKE	TF-157	T301	1	
AT373ZHBAE	BTFY0215001	TRANS	TF-215	T302	1	
AT373ZHBAE	BTPG0138001	TEST PIN	TP-138 IPS-1820-01-PT	TP001	1	
AT373ZHBAE	BTPG0138001	TEST PIN	TP-138 IPS-1820-01-PT	TP002	1	
AT373ZHBF	BWFG3830550	FLAT CABLE	WF-383 3.5-55-3.5 3P	WF701	1	
AT373ZHBBE	BWFG3830750	FLAT CABLE	WF-383 3.5-75-3.5 3P	WF801	1	
AT373ZHBBE	BWFG3840700	FLAT CABLE	WF-384 3.5-70-3.5 4P	WF802	1	
AT373ZHBDE	BWFG3850550	FLAT CABLE	WF-385 3.5-55-3.5 5P	WF552	1	
AT373ZHBBE	BWFG3850650	FLAT CABLE	WF-385 3.5-65-3.5 5P	WF651	1	
AT373ZHBCB	BWFG3860500	FLAT CABLE	WF-386 3.5-50-3.5 6P	WF601	1	
AT373ZHBCB	BWFG3860500	FLAT CABLE	WF-386 3.5-50-3.5 6P	WF602	1	
AT373ZHBBE	BWFG3860500	FLAT CABLE	WF-386 3.5-50-3.5 6P	WF751	1	
AT373ZHBDE	BWFG3880500	FLAT CABLE	WF-388 3.5-50-3.5 8P	WF551	1	
AT373ZHXYE	BWZY0517001	CORD:DC CORD	WZ-517 1515 W/P	WA951	1	
AT373ZHBYE	BYDY0019003	BUSHING	YD-019 B312D-11-A	Y1501	1	
AT373ZHBYE	BYYY0027001	INSULATION SHEET	YY-027	Y501	1	
AT373ZHBYE	BYYY0027001	INSULATION SHEET	YY-027	Y502	1	
AT373ZHBAAW	CUAH015011G	WIRE	UL 1007 #24 3-150- 3 GR	W001	1	
AT373ZHBAAW	CUAJ015011G	WIRE	UL 1007 #24 3-150-3 WHT	W002	1	

ASSY CODE	PARTS CODE	DESCRIPTION	SPEC	REF NO	QTY	REMARKS
AT373ZHBAW	CUPJ003511G	WIRE W-004	UL 1571 #26 3- 35- 3 WHT	W003	1	
AT373ZHBAW	CUPJ004011G	WIRE W-004	UL 1571 #26 3- 40- 3 WHT	W005	1	
AT373ZHBAW	CUPK004011G	WIRE W-004	UL 1571 #26 3- 40- 3 BLK	W004	1	
AT373ZHBYM	GCAS2C2896Z	PANEL:FRONT	ABS		1	
AT373ZHXYM	GMSC405736A	SCREW:MOUNTING	ABS INST CLR BLACK		2	ACC
AT373ZHBYM	GNBZ4C3126Z	KNOB	ABS		1	
AT373ZHBYM	GNBZ4C3127Z	KNOB	ABS		2	
AT373ZHBYM	GNBZ4C3128Z	KNOB	ABS		1	
AT373ZHBYM	GNBZ4C3129Z	KNOB	ABS		1	
AT373ZHXYM	HBC1304880Z	MOUNTING BRACKET	SPCC,1.6T ZMC		1	ACC
AT373ZHBYM	HCAS3C2899Z	COVER:TOP	VINY TOP		1	
AT373ZHBYM	HCAS3C2900Z	COVER:BOTTOM	VINY TOP		1	
AT373ZHBYM	HCAS3C2902Z	FRONT PIECE	A1070P(AL)		1	
AT373ZHBYM	HCSY2C2897Z	CHASSIS	SECC		1	
AT373ZHBYM	HHDZ3C3122Z	HOLDER:SWITCH	SECC		1	
AT373ZHBYM	HHDZ442021Z	HOLDER:DEVICE	SPCC,ZMC		1	METER
AT373ZHBYM	HHDZ4C3123Z	HOLDER:DEVICE	SECC		1	
AT373ZHBAM	HHSK352588Z	HEAT SINK	C2680(BSP)		1	
AT373ZHBYM	HHSK4C2901Z	HEAT SINK	A1070P(AL)		1	
AT373ZHXYM	HMHG402919Z	HANGER:MICROPHONE	SPCC,1.0T,NI		1	ACC
AT373ZHBAM	HSDC452454Z	SHIELD CASE	SPT		1	
AT373ZHBYM	KDPC411521Z	OPTICAL FILTER:DISPLAY	ACRYL,1.0T,ORANGE		1	PANEL:FRONT
AT373ZHBDM	LHDL412881B	HOLDER:LED	EPT,NON-CARBON		2	LED PCB
AT373ZHXYM	LWSR493891Z	WASHER:RUBBER	EPT, BLACK 7X15X2.0T		2	ACC BRACKET
AT373ZHBYM	NSPZ4C3267Z	COIL SPRING	SWIC-F		1	PANEL:FRONT
AT373ZHBYM	PLBC482147Z	LABEL:WARNING,DC CORD	PAPER,PRINT		1	DC CORD
AT373ZHBYM	PLBS459498Z	LABEL:ID	PAPER		2	D/BOX*1, CARTON*1
AT373ZHBYM	PLBS4C3237Z	LABEL:ID	**		1	CHASSIS
AT373ZHBYM	PLBZ393435Z	CB STICKER (B)	**		1	ACC
AT373ZHBYM	PLBZ493437A	WIRING STICKER	**		1	CASE:TOP
AT373ZHBYM	RBLD4C4211Z	HIMELON	**		2	METER
AT373ZHBYM	RCUN404172A	CUSHION	NEOPRENE SP,3T BLACK		2	METER
AT373ZHBAM	RCUN435264Z	CUSHION	NEOPRENE SP 25*15*15T		1	MAIN PCB
AT373ZHBYM	RCUN4B6610Z	CUSHION	NEOPRENE		1	COVER:BOTTOM
AT373ZHBYM	RETC412489Z	BLIND PLATE	PVC 0.4T BLACK		1	7 SEG LED
AT373ZHBYM	RETC425492A	DOUBLE-SIDED TAPE	**		2	BLIND PLATE
AT373ZHBYM	RETC490493A	SPACER	WOOL TACK,0.5T,BLACK		2	CHASSIS
AT373ZHBYM	RUTC4C3268Z	WOOL COATED PAPER:WOOL TACK	**		4	COVER:TOP*2,BOTTOM*2
AT373ZHBYM	RZEB407154Z	INSULATION PLATE	PVC,30*20*0.5T		1	COVER:TOP
AT373ZHBYM	SSCW133005N	SCREW:FLAT HD +	M3X5 NI	1	4	PANEL:FRONT-CHASSIS
AT373ZHBYM	SSCW192004N	SCREW:BIND HD +	M2X4 NI	1	8	SLIDE SW 2P
AT373ZHBYM	SSCW192604N	SCREW:BIND HD +	M2.6X4 NI	1	2	SLIDE SW 3P
AT373ZHBYM	SSCW193006D	SCREW:BIND HD +	M3X6 BZMC	1	12	COVER:TOP,BOTTOM
AT373ZHBYM	SSCW193008D	SCREW:BIND HD +	M3X8 BZMC	1	4	SPEAKER
AT373ZHBAM	SSCW193008N	SCREW:BIND HD +	M3X8 NI	1	1	TR-HEATSINK

ASSY CODE	PARTS CODE	DESCRIPTION	SPEC	REF NO	QTY	REMARKS
AT373ZHBYM	SSCW193010N	SCREW:BIND HD +	M3X10 NI	1	4	CHASSIS-HEATSINK-TR
AT373ZHXYM	SSCW293508N	SCREW:TAPPING ROUND HD +	D3.5X8 NI	1	2	ACC MIC HANGER
AT373ZHXYM	SSCW295010N	SCREW:TAPPING ROUND HD +	D5X10 NI	1	2	ACC BRACKET
AT373ZHBYM	SSCW343006N	SCREW:TAPTIGHT BIND HD +	M3X6 NI	1	2	DC CONNECTOR
AT373ZHBYM	SSCW343006N	SCREW:TAPTIGHT BIND HD +	M3X6 NI	2	5	MAIN PCB
AT373ZHBYM	SSCW430030N	HEX NUT	M3.0 NI	1	4	TR, HEATSINK
AT373ZHBYM	SSCW480030Z	NUT:FLANGE	M3 ZMC	1	4	SPEAKER
AT373ZHXYM	SSCW530035N	WASHER:LOCK	D3.5 NI	1	2	ACC MIC HANGER
AT373ZHXYM	SSCW540050N	WASHER:STAR	D5 NI	1	2	ACC BRACKET
AT373ZHBYM	SSCW802608N	SCREW:P TIGHT BIND HD +	D2.6X8 NI	1	2	LED PCB
AT373ZHBYM	SSCW802608N	SCREW:P TIGHT BIND HD +	D2.6X8 NI	2	4	HOLDER:SW,HOLDER:DEVICE
AT373ZHBYM	TSTD0200001	SPRING PLATE:KNOB	D3.5XL5.2		1	INNER KNOB
AT373ZHBYM	TSTD0200002	SPRING PLATE:KNOB	D6XL5.2		1	OUTER KNOB
AT373ZHBYM	TSTD0200003	SPRING PLATE:KNOB	D6.02XL9.53		3	CH KNOB*1,KNOB*2
AT373ZHXYM	UTZZ01373ZZ	OWNERS MANUAL	**		1	
AT373ZHXYM	WBAG4C3715Z	PACKING BAG	**		1	ACC
AT373ZHXYM	WBAG4C3716Z	PACKING BAG	**		1	DC CORD
AT373ZHXYM	WBAG4C3718A	PACKING BAG	**		1	OWNER'S MANUAL
AT373ZHXYM	WBAG4C3726Z	PACKING BAG	**		0.16667	1/6 S/CARTON BOX
AT373ZHXYM	WBAG4C3727Z	PACKING BAG	**		1	UNIT
AT373ZHXYM	WBXZ3C3131Z	DISPLAY BOX	**		1	PDP
AT373ZHXYM	WCTZ3C4256Z	SHIPPING CARTON BOX	**		0.16667	1/6 PDP
AT373ZHXYM	WSLV3C4257Z	SLEEVE	**		1	UNIT
AT373ZHXYM	WSLV3C4258Z	SLEEVE	**		1	ACC
AT373ZHXYM	WSLV3C4259Z	SLEEVE	**		1	
AT373ZHXYM	WSLV4C4260Z	SLEEVE	**		1	